

Modbus Protocol COMMUNICATIONS MANUAL

For Series B Digital Panel Meters,
Counters, Timers and Transmitters



ELECTRO-NUMERICS, INC.

1. TABLE OF CONTENTS

1.	TABLE OF CONTENTS	2
2.	INTRODUCTION, MODBUS SERIAL LINE PROTOCOL	3
3.	JUMPER SETTINGS & FIELD WIRING FOR MODBUS OPERATION	4
4.	PROGRAMMING YOUR MODBUS DEVICE.....	6
5.	MODBUS PROTOCOL IMPLEMENTATION	8
	1.0 General	8
	2.0 Framing.....	8
	3.0 Electrical Interface	9
	4.0 Parameters Selectable via Instrument Setup (IS) Software	9
	5.0 Parameters Selectable via Front Panel Meter Setup.....	9
	6.0 Supported Function Codes	9
	7.0 Supported Exception Response Codes	12
	8.0 Message Formatting	12
	10.0 Data Types Internal Registers	14
	11.0 DPM & Analog Input Transmitter Internal Register Addresses	15
	12.0 Weight Meter Internal Register Addresses.....	20
	13.0 Counter / Timer Internal Register Addresses	25
6.	WARRANTY	32

2. INTRODUCTION, MODBUS SERIAL LINE PROTOCOL

The Modbus Protocol is an industry-standard serial communications protocol which can be used with RS232 or RS485 signals, but is normally only used with RS485. This is because RS232 is designed for point-to-point communications and is limited to line lengths up to 50 ft (9 m), while RS485 is designed for multidrop communications and allows line length up to 1 mile (1.6 km).

With the Modbus Protocol and RS485, up to 32 devices by different manufacturers can share the same RS485 data line without a repeater, be connected using similarly-wired RJ45 connectors, and be addressed with up to 247 digital addresses. A computer is required in a Modbus system. The Modbus Serial Line protocol is a master-slave protocol, where a master node (computer) issues commands to slave nodes (peripheral devices) on the bus and processes responses.

Modbus I/O capability is offered as an option with our Series 2 digital panel meters, counters and timers, and is a standard selectable feature of our DIN rail transmitters. The Modbus protocol is implemented by the microcomputer on the main board and is compliant with the Modbus RTU or ASCII transmission modes (software selectable).

Digital panel meters, counters and timers require a serial communications plug-in option board for use of the Modbus protocol. This can be an RS232 board, RS485 board, or Modbus board. The RS485 and Modbus boards are both RS485 compliant, but the RS485 board uses RJ11 connectors while the Modbus board uses RJ45 connectors as specified for Modbus. With the Modbus board and Modbus protocol, the instruments are fully compliant with Modbus over Serial Line Specification V1.0 (2002). This includes RJ45 connectors and 2-wire half-duplex or 4-wire full-duplex operation (jumper selectable). The two RJ45 or RJ11 connectors are wired in parallel to allow device daisy chaining with no need for a hub. One of the jacks is equipped with two indicator LEDs.

DIN rail transmitters offer serial I/O capability as standard feature, as implemented on the main board. The interface is via a three-position screw clamp connector (D0, D1, Ground). RS232 or RS485 signal levels are jumper selectable. The factory default jumper setting is RS485 for TM Series (Modbus) transmitters and RS232 for TA Series (analog) transmitters. The Modbus protocol is selectable in software using Windows-based Instrument Setup (IS) Software. With three connector positions, only 2-wire half-duplex operation can be implemented; however, the protocol is fully compliant with Modbus over Serial Line Specification V1.0 (2002).

The Custom ASCII Protocol is a software-selectable alternative to the Modbus Protocol. This protocol can also be used with RS232 or RS485 signals and allows digital addressing. It is less complex than the Modbus protocol; however, it is not an industry standard. For information on the Custom ASCII Protocol, please refer to our separate Custom ASCII Protocol Communications Manual.

3. JUMPER SETTINGS & FIELD WIRING FOR MODBUS OPERATION

1. SAFETY WARNINGS



Digital panel meters, counters, timers and transmitters may be powered with AC (mains) from 95-240V ac $\pm 10\%$ or 95-300V dc with the high voltage power supply option, or 10-34V ac $\pm 10\%$ or 10-48 Vdc with the low voltage power supply option. To avoid the possibility of electrical shock or damaging short circuits, always unplug the device before opening the case. Please refer to the respective device manuals for full safety information and instruction on how to open the case. Signal wiring changes external to the case can be made safely while the units are under power.

2. JUMPERS OF RS485 & RS485-MODBUS BOARDS

Full Duplex Operation

- b & e** - These bias jumpers should be installed on 1 (and only 1) meter.
- a & d** - Installed on last meter in line with long cable runs.

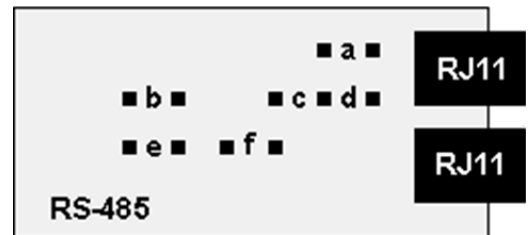

Half Duplex Operation

- b & e** - Bias jumpers installed on 1 meter.
- c & f** - Installed for half duplex operation.
- a** - Installed on last meter in line with long cable runs.

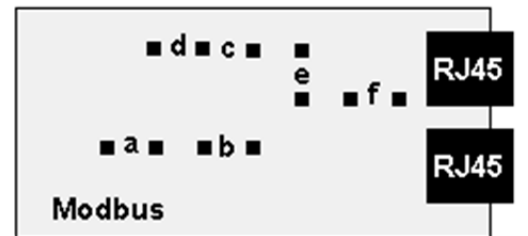

Note: Boards are shipped with no jumpers installed.

3. RJ45 CONNECTOR WIRING, DEVICE TO COMPUTER

RS485-MODBUS - FULL DUPLEX

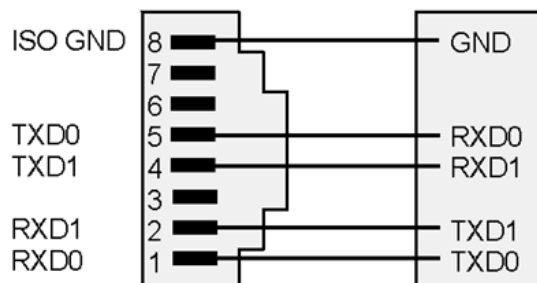

RS485-MODBUS - HALF DUPLEX

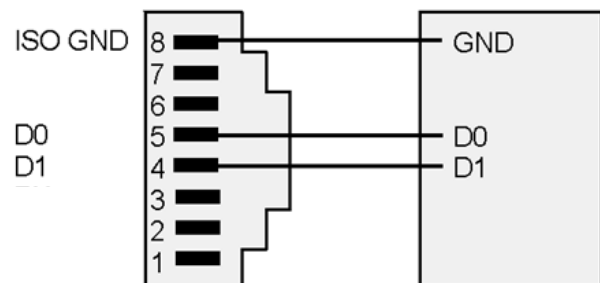

4. JUMPERS OF TRANSMITTER MAIN BOARD

Serial Data Format	Jumpers
RS232	a, c
RS485	b, d

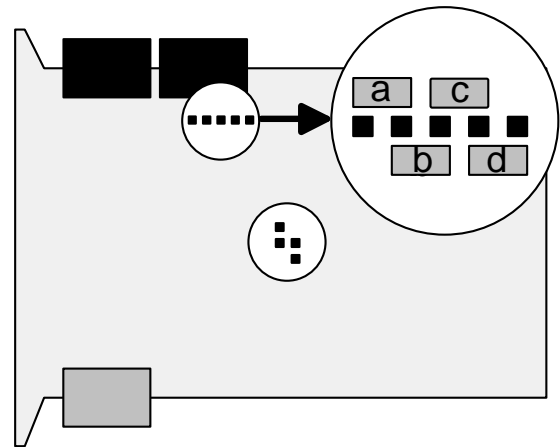

5. TRANSMITTER CONNECTOR WIRING

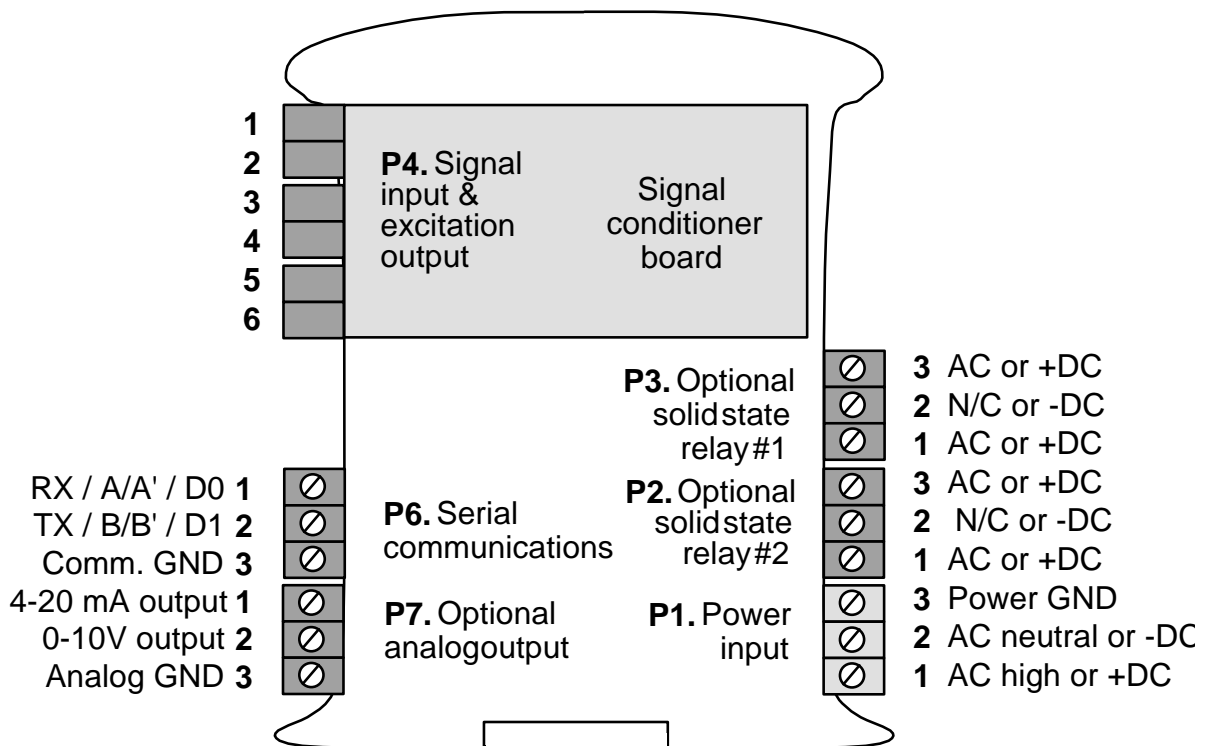

P6 - COMMUNICATIONS DETAIL

Wiring of serial cable to PC

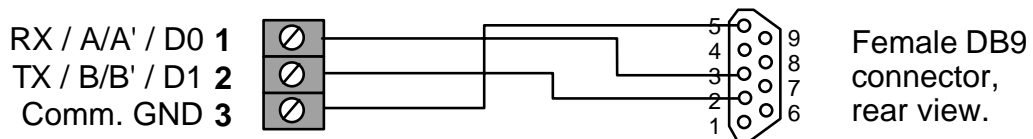

4. PROGRAMMING YOUR MODBUS DEVICE

OVERVIEW

Modbus digital panel meters, counters, timers and transmitters are easily programmed via their serial port using Windows-based **Instrument Setup (IS)** software, which provides a graphical user interface and is available at no charge. This software allows uploading, editing, downloading and saving of setup data, execution of commands under computer control, listing, plotting and graphing of data, and computer prompted calibration. Digital panel meters, counters and timers can also be programmed via their 4-key front panel as explained in their respective manuals; however, front panel programming not recommended when serial communications are available.

INSTRUMENT SETUP SOFTWARE INSTALLATION FROM CD ROM

Insert the CD ROM into your PC. The CD is self-booting and will present you with a menu of choices. Click on "Install Instrument Setup Software" and follow the prompts.

GETTING STARTED WITH IS SOFTWARE

To launch IS software, press *Start* => *Programs* => *IS64* => *IS2*. Click on your device type. The program will temporarily set the selected COM port to the selected baud rate, protocol, and parity. Once communications have been established, click on *Main Menu*.

The best way to learn IS software is to experiment with it. From the Main Menu, click on *Get Setup* to retrieve (or get) the existing setup data from your device. Click on *View* => *Setup* to bring up screens which allow you to edit the setup file using pull-down menus and other selection tools. You can save your file to disk by clicking on *File* => *Save Setup*. You can download (or put) your edited file into the transmitter by clicking on *Put Setup*. Programmable items will only be displayed if you have told the software that you have the appropriate hardware, such as the dual relay option. Pressing the *F1* key at any time will bring up detailed help information.

An optional analog output is defined in two steps. The input to the device is first scaled to a digital reading in engineering units, and this reading is then converted to the analog output. The digital reading is also used for setpoint control and can be transmitted as serial data.

ADDITIONAL FEATURES

- **The Commands pull-down menu** allows you to execute certain functions by using your computer mouse. The *Commands* pull-down menu will be grayed out unless a *Get Setup* has been executed.
- **The Readings pull-down menu** provides three formats to display input data on your PC monitor. In all formats, use the *Pause* and *Continue* buttons to control the timing of data collection, then press *Print* for a hardcopy on your PC printer.

- **List** presents the latest digital readings in a 20-row by 10-column table. Press *Pause* at any time to freeze the display. Press *Print* for a hardcopy.
- **Plot** generates a plot of digital readings vs. time in seconds. It effectively turns the instrument-PC combination into a printing digital oscilloscope.
- **Graph** generates a histogram, where the horizontal axis is the reading and the vertical axis is the number of readings. The display continually resizes itself as the number of readings increases.

5. MODBUS PROTOCOL IMPLEMENTATION

1.0 GENERAL

The Modbus capability conforms to the Modbus over Serial Line Specification & Implementation guide, V1.0. Both the Modbus RTU and Modbus ASCII protocols are implemented:

Modbus RTU

Baud Rate..... 300, 600, 1200, 2400, 4800, 9600 or 19200
Data Format 1 start bit, 8 data bits, 1 parity bit, 1 stop bit (11 bits total)
Parity..... None, Odd, Even (if None, then 2 Stop bits for 11 total)
Address..... 0 for broadcast, 1-247 for individual meters

Modbus ASCII

Baud Rate..... 300, 600, 1200, 2400, 4800, 9600 or 19200
Data Format 1 Start bit, 7 Data bits, 1 Parity bit, 1 Stop bit (10 bits total)
Parity..... None, Odd, Even (if None, then 2 Stop bits for 10 total)
Address..... 0 for broadcast, 1-247 for individual meters

2.0 FRAMING

Modbus RTU

Message frames are separated by a silent interval of at least 3.5 character times. If a silent interval of more than 1.5 character times occurs between two characters of the message frame, the message frame is considered incomplete and is discarded. Frame Check = 16 bit CRC of the complete message excluding CRC characters.

Modbus ASCII

The message begins immediately following a colon (:) and ends just before a Carriage Return/Line Feed (CRLF). All message characters are hexadecimal 0-9, A-F (ASCII coded). The system allowable time interval between characters may be set to 1, 3, 5 or 10 seconds. Frame Check = 1 byte (2 hexadecimal characters) LRC of the message excluding the initial colon (:) and trailing LRC and CRLF characters.

3.0 ELECTRICAL INTERFACE

Four-wire (plus common) full-duplex or two-wire (plus common) half-duplex RS485 signal levels are jumper selectable for digital panel meters, counters and timers. A polarization resistor and termination resistor are also jumper selectable. In case of a long line (greater than 500 ft) to the first device, a termination resistor should be selected for the first device. In case of a long line length (greater than 500 ft) between the first and last devices, a termination resistor should be selected for the first and last devices. Never add termination resistors to more than two devices on the same line. A two-wire, half-duplex RS485 signal level is jumper selectable for transmitters.

4.0 PARAMETERS SELECTABLE VIA INSTRUMENT SETUP (IS) SOFTWARE

Serial Protocol Custom ASCII, Modbus RTU, Modbus ASCII
 Modbus ASCII Gap Timeout..... 1 sec, 3 sec, 5 sec, 10 sec
 Baud Rate..... 300, 600, 1200, 2400, 4800, 9600, 19200
 Parity No parity, odd parity, even parity
 Device Address 0 to 247

5.0 PARAMETERS SELECTABLE VIA FRONT PANEL METER SETUP

The two menu items related specifically to Modbus setup are SEr_4 and Addr.

Ser_4 Serial Comm 4	000 Modbus ASCII Gap Timeout	0 1 2 3	1 Sec 3 Sec 5 Sec 10 Sec
	000 Serial Protocol	0 1 2	Custom ASCII (Non-Modbus) Modbus RTU Modbus ASCII
	000 Parity	0 1 2	No Parity Odd Parity Even Parity
Addr Meter Address	000	Set to desired address 1-247	

The baud rate is set in SEr_1 per the Meter manual. The selection of Modbus RTU or Modbus ASCII in SEr_4 above overrides any LF or Command Mode selections that have been made, since they are determined by the Modbus protocol.

6.0 SUPPORTED FUNCTION CODES

FC03: Read Holding Registers

Reads internal registers containing setup parameters (Scale, Offset, Setpoints, etc.)

FC10: Write Multiple Registers (FC10 = 16 dec)

Writes internal registers containing setup parameters (Scale, Offset, Setpoints, etc.)

FC04: Read Input Registers

Reads measurement values and alarm status. Returns values in 2's Complement Binary Hex format without a decimal point. The displayed system decimal point can be read with FC03 at address 0057. Use only **odd** Register Addresses and an **even** number of Registers.

Register Address	DPM, Weight Meter, or Analog Input Transmitter Response	Counter, Timer, or Pulse Input Transmitter Response
00 01	Hi word of Alarm status	Hi word of Alarm status
00 02	Lo word of Alarm status	Lo word of Alarm status
00 03	Hi word of Measurement value	Hi word of Item 1 value
00 04	Lo word of Measurement value	Lo word of Item 1 value
00 05	Hi word of Peak value	Hi word of Peak value
00 06	Lo word of Peak value	Lo word of Peak value
00 07	Hi word of Valley value	Hi word of Valley value
00 08	Lo word of Valley value	Lo word of Valley value
00 09	N/A	Hi word of Item 2 value
00 0A	N/A	Lo word of Item 2 value
00 0B	N/A	Hi word of Item 3 value
00 0C	N/A	Lo word of Item 3 value

FC05: Write Single Coil

Action command to device

Output Address	Output Value	Action Command
00 01	FF 00	Device Reset (No Response)
00 02	FF 00	Function Reset (Peak, Valley)
00 03	FF 00	Latched Alarm Reset
00 04	FF 00	Peak Reset
00 05	FF 00	Valley Reset
00 06	FF 00	Remote Display Reset (Counters in Remote Display Mode)
00 07	FF 00	Display Item 1 (Meters, Counters, Timers)
00 08	FF 00	Display Item 2 (Counters, Timers, Weight Meter)
00 09	FF 00	Display Item 3 (Counters, Timers)
00 0A	FF 00	Display Peak (Meters, Counters, Timers)
00 0B	FF 00	Display Valley (Meters, Counters, Timers)
00 0C	FF 00	Tare (Weight Meters, Transmitters. Value = 00 00 resets Tare)
00 0D	FF 00	Meter Hold (output value = 00 00 resets Meter Hold)
00 0E	FF 00	Blank Display (output value = 00 00 resets Display Blank)
00 0F	FF 00	Activate External Input A (output value = 00 00 deactivates)
00 10	FF 00	Activate External Input B (output value = 00 00 deactivates)

FC08: Diagnostics

Checks communications between the Master and Slave, and returns the count in the Modbus Slave counters (which are reset when the meter is reset).

Hex Sub Function Code	Data Send	Response Data	Description
00 00	Any	Same	Returns Query Data (N x 2 bytes). Echo Request.
00 01	FF 00 00 00	FF 00 00 00	Restarts Communications. If in the Listen-Only mode, no response occurs. Takes Slave out of the Listen-Only mode and one of the following: — Clears communications event counters. — Does not clear communications event counters.
00 04	00 00	None	Forces Listen-Only. All addressed and broadcast Messages are monitored and counters are incremented, but no action is taken or response sent. Only Sub-Function 00 01 causes removal of this Listen-Only state.
00 0A	00 00	00 00	Clears all Modbus slave counters.
00 0B	00 00	Total Message Count	Returns total number of messages detected on the bus, including those not addressed to this Slave. Excludes bad LRC/CRC, parity error or length < 3.
00 0C	00 00	Checksum Error Count	Returns total number of messages with bad LRC/CRC, parity or length < 3 errors detected on the bus including those not addressed to the Slave.
00 0D	00 00	Exception Error Count	Returns total number of Exception responses returned by the Addressed Slave or that would have been returned if not a broadcast message or if the Slave was not in a Listen-Only mode.
00 0E	00 00	Slave Message Count	Returns total number of messages, either broadcast or addressed to the Slave. Excludes bad LRC/CRC, parity or length < 3 errors.
00 0F	00 00	No Response Count	Returns total number of messages, either broadcast or addressed to the Slave, for which Slave has returned No Response, neither a normal response nor an exception response. Excludes bad LRC/CRC, parity or length < 3 errors.
00 11	00 00	Slave Busy	Returns total number of Exception Code 6 (Slave Busy) responses.

7.0 SUPPORTED EXCEPTION RESPONSE CODES

Code	Name	Error Description
01	Illegal Function	Illegal Function Code for this Slave. Only hex Function Codes 03, 04, 05, 08, 10 (dec 16) are allowed.
02	Illegal Data Address	Illegal Register Address for this Slave.
03	Illegal Data Value	Illegal data value or data length for the Modbus protocol.
04	Slave Device Failure	Slave device failure (eg. Device set for external gate).

8.0 MESSAGE FORMATTING

MA = Meter Address	DD = Data (Hex)	CL = CRC Lo Byte
FC = Function Code	WW = Data (On/Off)	CH = CRC Hi Byte
RA = Register Address	SF = Sub-Function	CR = Carriage Return
NR = Number of Registers	EC = Error Code	LF = Line Feed
NB = Number of bytes	LRC = ASCII Checksum	

Modbus RTU Format

FC	Action	> 3.5 Char	Byte Number										
			1	2	3	4	5	6	7	8	9	10	11
03	Request	NoTx	MA	FC	RA	RA	NR	NR	CL	CH			
03	Response	NoTx	MA	FC	NB	DD*	DD*	CL	CH				
04	Request	NoTx	MA	FC	RA	RA	NR	NR	CL	CH			
04	Response	NoTx	MA	FC	NB	DD*	DD*	CL	CH				
05	Request	NoTx	MA	FC	RA	RA	WW	WW	CL	CH			
05	Response	NoTx	MA	FC	RA	RA	WW	WW	CL	CH			
08	Request	NoTx	MA	FC	SF	SF	WW	WW	CL	CH			
08	Response	NoTx	MA	FC	SF	SF	DD	DD	CL	CH			
10	Request	NoTx	MA	FC	RA	RA	NR	NR	NB	DD*	DD*	CL	CH
10	Response	NoTx	MA	FC	RA	RA	NR	NR	CL	CH			
	Exception Response	NoTx	MA	FC +80	EC	CL	CH						

DD* = (DD DD) times NR (Number of Registers)

Modbus ASCII Format

FC	Action	Byte Number												
		1	2	3	4	5	6	7	8	9	10	11	12	13
03	Request	:	MA	FC	RA	RA	NR	NR	LRC	CR	LF			
03	Response	:	MA	FC	NB	DD*	DD*	LRC	CR	LF				
04	Request	:	MA	FC	RA	RA	NR	NR	LRC	CR	LF			
04	Response	:	MA	FC	NB	DD*	DD*	LRC	CR	LF				
05	Request	:	MA	FC	RA	RA	WW	WW	LRC	CR	LF			
05	Response	:	MA	FC	RA	RA	WW	WW	LRC	CR	LF			
08	Request	:	MA	FC	SF	SF	WW	WW	LRC	CR	LF			
08	Response	:	MA	FC	SF	SF	DD	DD	LRC	CR	LF			
10	Request	:	MA	FC	RA	RA	NR	NR	NB	DD*	DD*	LRC	CR	LF
10	Response	:	MA	FC	RA	RA	NR	NR	LRC	CR	LF			
Exception Response		:	MA	FC +80	EC	LRC	CR	LF						

DD* = (DD DD) times NR (Number of Registers)

9.0 MESSAGE EXAMPLES FOR DEVICE ADDRESS = 01, NO PARITY

Example	Action	Modbus RTU	Modbus ASCII
		Ser_4 = 010 Addr = 001	Ser_4 = 020 Addr = 001
Restart Com- munications	Request Response*	010800010000B1CB 010800010000B1CB	:010800010000F6crlf :010800010000F6crlf
Meter Reset	Request Response	01050001FF00DDFA None	:01050001FF00FAcrlf None
Digital Reading ** ***	Request Response	01040003000281CB 010404000009D67C4A	:010400030002F6crlf :010404000009D618crlf
Write Setpoint 1 = +37.00***	Request Response	0110000100020400000E743624 01030400000E74FE74	:0110000100020400000E7466crlf :011000010002ECcrlf
Read Setpoint 1 = +37.00***	Request Response	01030001000295CB 01030400000E74FE74	:010300010002F9crlf :01030400000E7476crlf
Send -12.34 to Remote Display ***	First send decimal point, address 0057 as 00 03. 1234 decimal = 000004D2 hex.		
	Request Response	01100069000204FFFFFB2EF6E5 01100069000291D4	01100069000204FFFFFB2E59crlf 01100069000284crlf

* Suggested as first message after power-up. If transmitter is in Listen-Only mode, no response is returned. 1234 decimal = 000004D2 hex. -1234 = FF FF FB 2E in 4-byte 2's complement hex.

** Example while reading +25.18 *** Decimal point is ignored.

Because the Counter/Timer can provide up to 3 display items during normal operation, it can be used to provide additional features when used as a Remote Display. It is possible to send Remote Data to Item 3 using address 006C, and if the Counter/Timer is setup with the "Source" menu item is set to Item 3, it will make alarm comparisons to its Setpoints using the Remote Data. Likewise, the Analog Output will respond to the Remote Data if "AnSEt" selects Item 3 for the Analog Output source and the Display mode (Config Dig 3 = 7).

Address 0069 sends Remote Data to the display only (any Display mode).

Address 006B sends Remote Data to Item 3 only for Alarms and/or Analog Out.

Address 006D sends Remote Data to both the display and Item 3.

10.0 DATA TYPES INTERNAL REGISTERS

S = Sign Bit, 0 = Positive, 1 = Negative.

DDD = Decimal Point XXXXX. = 1 (Magnitude x 10⁰)
 XXXXX.X = 2 (Magnitude x 10⁻¹)
 XXXX.XX = 3 (Magnitude x 10⁻²)
 XXX.XXX = 4 (Magnitude x 10⁻³)
 XX.XXXX = 5 (Magnitude x 10⁻⁴)
 X.XXXXX = 6 (Magnitude x 10⁻⁵)

Note: The DPM & Weight meter only have 5 display digits and decimal points.

C = Bits of 2's Complement Binary Value

M = Bits of Positive Binary Magnitude

B = Bits of Configuration Data

2C32 Two's Complement (4 bytes)

<u>Hi Word (Register)</u>	<u>Lo Word (Register)</u>
CCCC CCCC CCCC CCCC	CCCC CCCC CCCC CCCC

Most significant C bit is sign:
 C = 0 positive
 C = 1 negative

2C24 Decimal Point + Two's Complement (4 bytes)

<u>Hi Word (Register)</u>	<u>Lo Word (Register)</u>
0000 0DDD CCCC CCCC	CCCC CCCC CCCC CCCC

M32 Binary Magnitude

<u>Hi Word (Register)</u>	<u>Lo Word (Register)</u>
MMMM MMMM MMMM MMMM	MMMM MMMM MMMM MMMM

M48 Binary Magnitude

<u>Hi Word (Register)</u>	<u>Mid Word (Register)</u>	<u>Lo Word (Register)</u>
XXXX XXXX MMMM MMMM	MMMM MMMM MMMM MMMM	MMMM MMMM MMMM MMMM

Ignore XXXX XXXX - Use LS 5-byte result

B16 Bit Significance

<u>Hi Byte</u>	<u>Lo Byte</u>
0000 0000	BBBB BBBB
	7654 3210

11.0 DPM & ANALOG INPUT TRANSMITTER INTERNAL REGISTER ADDRESSES FC03 & FC10 (dec16)

Use only odd-numbered starting Register Addresses from 1 to 43 (Dec) and an even number of Registers.

Register Address		Register Name	Data Type	Scaling & Decimal Point
Dec	Hex			
1	0001	Setpoint 1 (Hi word)	2C32	Dec pt. same as displayed.
2	0002	Setpoint 1 (Lo word)	2C32	
3	0003	Setpoint 2 (Hi word)	2C32	Dec pt. same as displayed.
4	0004	Setpoint 2 (Lo word)	2C32	
5	0005	Setpoint 3 (Hi word)	2C32	Dec pt. same as displayed.
6	0006	Setpoint 3 (Lo word)	2C32	
7	0007	Setpoint 4 (Hi word)	2C32	Dec pt. same as displayed.
8	0008	Setpoint 4 (Lo word)	2C32	
9	0009	Scale (Hi word)	2C32	Scale = .00001 x dec value
10	000A	Scale (Lo word)	2C32	of Hi word + Lo word
11	000B	Offset (Hi word)	2C32	Dec pt. same as displayed.
12	000C	Offset (Lo word)	2C32	
17	0011	Lo In (Hi word)	2C32	Uses Dec pt. of input range.
18	0012	Lo In (Lo word)	2C32	
19	0013	Lo Rd (Hi word)	2C32	Dec pt. same as displayed.
20	0014	Lo Rd (Lo word)	2C32	
21	0015	Hi In (Hi word)	2C32	Uses Dec pt. of input range.
22	0016	Hi In (Lo word)	2C32	
23	0017	Hi Rd (Hi word)	2C32	Dec pt. same as displayed.
24	0018	Hi Rd (Lo word)	2C32	
25	0019	Rd0 (Hi word)	2C32	Dec pt. same as displayed.
26	001A	Rd0 (Lo word)	2C32	
33	0021	Deviation 1 (Hi word)	M32	Dec pt. same as displayed.
34	0022	Deviation 1 (Lo word)	M32	
35	0023	Deviation 2 (Hi word)	M32	Dec pt. same as displayed.
36	0024	Deviation 2 (Lo word)	M32	
37	0025	Deviation 3 (Hi word)	M32	Dec pt. same as displayed.
38	0026	Deviation 3 (Lo word)	M32	
39	0027	Deviation 4 (Hi word)	M32	Dec pt. same as displayed.
40	0028	Deviation 4 (Lo word)	M32	
41	0029	Analog Lo (Hi word)	2C32	Dec pt. same as displayed.
42	002A	Analog Lo (Lo word)	2C32	
43	002B	Analog Hi (Hi word)	2C32	Dec pt. same as displayed.
44	002C	Analog Hi (Lo word)	2C32	

For the following, use any starting Register Address and any number of Registers. The data type is B16, except for FC10 dec 16, where the data type is 2C32.

Register Address		Register Name	Bit Significance	
Dec	Hex			
65	0041	Alarm Config 1	Bit 0	0 = AL1 Hi Active 1 = Lo Active Bit 1 0 = AL1 Enabled, 1 = Disabled Bit 2 0 = AL2 Hi Active 1 = Lo Active Bit 3 0 = AL2 Enabled 1 = Disabled Bit 4 0 = AL1 Non-Latched 1 = Latched Bit 5 0 = AL2 Non-Latched 1 = Latched Bit 6 0 = Relay1 Active On 1 = Off Bit 7 0 = Relay2 Active On 1 = Off
66	0042	Alarm Config 2	Bits 2:0	# Readings before Alarms 1 & 2. 000 = 1, 001 = 2, 010 = 4, 011 = 8, 100 = 16, 101 = 32, 110 = 64, 111 = 128 Bit 3 AL1 0 = Deviation 1 = Hysteresis Bit 4 AL2 0 = Deviation 1 = Hysteresis Bit 5 0 = Deviation in Menu 1 = Omitted
67	0043	Alarm Config 3 (Alarms 3 & 4 are planned developments)	Bit 0	0 = AL3 Hi Active 1 = Lo Active Bit 1 0 = AL3 Enabled 1 = Disabled Bit 2 0 = AL4 Hi Active 1 = Lo Active Bit 3 0 = AL4 Enabled 1 = Disabled Bit 4 0 = AL3 Non-Latched 1 = Latched Bit 5 0 = AL4 Non-Latched 1 = Latched Bit 6 0 = Relay3 Active On 1 = Off Bit 7 0 = Relay4 Active On 1 = Off
68	0044	Alarm Config 4 (Alarms 3 & 4 are planned developments)	Bits 2:0	= # Readings before Alarm 3 & 4 000 = 1, 001 = 2, 010 = 4, 011 = 8, 100 = 16, 101 = 32 110 = 64 111 = 128 Bit 3 AL3 0 = Deviation 1 = Hysteresis Bit 4 AL4 0 = Deviation 1 = Hysteresis Bit 5 0 = Deviation in Menu 1 = Omitted
69	0045	Input Type	Lo Byte Hex value	40-4D Thermocouple JF, C, KF, KC, NF, NC, EF, EC, TF, TC, SF, SC, RF, RC 50-5C RTD 4dinF, 4dinC, 4ansiF, 4ansiC, 3dinF, 3dinC, 3ansiF, 3ansiC, 2dinF, 2dinC, 2ansiF, 2ansiC, Short 60-64 DC 0.2V, 2V, 20V, 200V, 660V 70-73 DC 2 mA, 20 mA, 200 mA, 5A A0-A2 Ratio 0.2V, 2V, 20V

			80-84 RMS 0.2V, 2V, 20V, 200V, 660V 90-93 RMS 2 mA, 20 mA, 200 mA, 5A C0-C4 Strain 20, 50, 100, 250, 500 mV D0-D4 Load Cell 20, 50, 100, 250, 500 mV
70	0046	Setup	<p>Bits 3:0 Ctrl In 1 Ctrl In 2 Both Reset</p> <p>Hex 0 MReset MHold Cold (M = Meter)</p> <p>Hex 1 FReset Pk, Vy Cold (F = Function)</p> <p>Hex 2 MHold Pk, Vy Func (D = Display)</p> <p>Hex 3 MHold Tare Cold</p> <p>Hex 4 Pk, Vy Tare Func</p> <p>Hex 5 Tare MReset Cold</p> <p>Hex 6 DP2 DP3 DP5 Neither = DP1</p> <p>Hex 7 DP3 DP4 DP6 Neither = DP2</p> <p>Hex 8 FReset DBlank Cold</p> <p>Hex 9 MHold DBlank Cold</p> <p>Hex A Pk, Vy DBlank Func</p> <p>Hex B Tare DBlank Cold</p> <p>Hex C Valley Peak Func</p> <p>Bits 5:4</p> <p>Hex 00 Scale using Scale, Offset</p> <p>Hex 01 Scale using Coordinates of 2 Points</p> <p>Hex 10 Scale using Reading Coordinates</p> <p>Bit 7 0 = 60 Hz, 1 = 50 Hz (Bit 6 = Spare)</p>
71	0047	Filter	<p>Bits 3:0 Filtering</p> <p>Hex 0 = Auto Filter, 1 = Batch 16, 2-9 = Moving Avg, 2 = .08S, 3 = .15S, 4 = .3S, 5 = .6S, 6 = 1.2S, 7 = 2.4S, 8 = 4.8S, 9 = 9.6S, A = Unfiltered</p> <p>Bit 4 Hex 0 = Low Adaptive, 1 = High Adaptive</p> <p>Bit 5 Hex 0 = Display Batch of 16, 1 = Display Filtered</p> <p>Bit 6 Hex 0 = Peak of Unfiltered, 1 = Peak of Filtered</p> <p>Bit 7 Hex 0 = Alarm source Unfiltered, 1 = Filtered</p>
72	0048	Options	Do Not Use. Serial Config 1,2,3 do not pertain to Modbus parameters, only Serial Config 4.
73	0049	Serial Config 1	<p>Bits 3:0 Time between Continuous Serial Outputs</p> <p>Hex 0=.017S, 1=.28S, 2=.57S, 3=1.1S, 4=2.3S, 5=4.5S, 6=9.1S, 7=18.1S, 8=36.3S, 9=1M13S, A=2M25S, B=4M50S, C=9M40S, D=19M20S, E=38M41S, F=77M21S</p> <p>Bits 6:4 Baud Rate</p> <p>000 = 300, 001 = 600, 010 = 1200, 011 = 2400, 100 = 4800, 101 = 9600, 110 = 19200</p> <p>Bit 7 0 = Send Unfiltered value, 1 = Send Filtered Val</p>

74	004A	Serial Config 2	<p>Bits 4:0 Meter Serial Address (0-31) [Non-Modbus] Hex 0 = Broadcast (01 = 1 to 0A = 10), 0F = 15, 10 = 16, 1F = 31</p> <p>Bit 5 0 = Continuous Mode, 1 = Command Mode</p> <p>Bit 6 0 = No Alarm data with readings, 1 = Alarm data</p> <p>Bit 7 0 = No LF following CR, 1 = LF following CR</p>
75	004B	Serial Config 3	<p>Bits 2:0 Data sent in serial output 0 = Reading, 1 = Peak, 2 = Valley, 3 = Rdg + Peak, 4 = Rdg + Valley, 5 = Rdg + Peak + Valley</p> <p>Bit 3 0 = Termination chars at end of all items 1 = " " at end of each item</p> <p>Bit 4 0 = Non-latching, RTS 1 = Latching RTS</p> <p>Bit 5 0 = Normal continuous serial transmission 1 = Special Start & Stop characters</p> <p>Bit 6 0 = Full Duplex, 1 = Half Duplex</p>
76	004C	Serial Config 4	<p>Bits 1:0 00 = No Parity, 01 = Odd Parity, 11 = Even Parity</p> <p>Bits 3:2 00 = Custom ASCII, 01 = Modbus RTU, 10 = Modbus ASCII</p> <p>Bits 5:4 Modbus ASCII Gap Timeout 00 = 1S, 01 = 3S, 10 = 5S, 11 = 10S</p>
77	004D	Config	<p>Bit 0 0 = Linear Curve, 1 = Custom Curve</p> <p>Bits 2:1 Spare</p> <p>Bits 4:3 Peak button display response 00 = Peak, 01 = Valley, 10 = Peak then Valley, 11 = Tare</p> <p>Bits 7:5 000 = Not Rate, 001 = Rate x 0.1, 010 = Rate x 1, 011 = Rate x 10, 100 = Rate x 100, 101 = Rate x 1000, 110 = Rate x 10000</p>
78	004E	Lockout 1	<p>0 = Enabled, 1 = Locked out</p> <p>Bit 0 Offset, Lo, Hi Read</p> <p>Bit 1 Scale, Lo, Hi In</p> <p>Bit 2 Filter</p> <p>Bit 3 Setup, Config, DP</p> <p>Bit 4 Input Type</p>

79	004F	Lockout 2	Bit 0 Bit 1 Bit 2 Bit 3 Bit 4 Bit 5 Bit 6 Bit 7	Serial Comm Config Analog Out Scaling Alarm Setpoint Programming Alarm Config Front Panel Meter Reset Front Panel Function Reset View Setpoints Tare & View Peak
81	0051	Setup 1	Bits 1:0	00 = 4-1/2 Digits, 0.1 degree 01 = Slave Remote Display 10 = 4-1/2 Dig/10, 0.01 degree 11 = 3-1/2 Digits, 1 degree
82	0052	Analog Output Setup	Bit 0 Bit 1	0 = Analog Out Source Unfiltered , 1 = Filtered 0 = Current Output, 1 = Voltage Output
87	0057	System Decimal Point	Bits 2:0	001 = ddddd., 010 = dddd.d, 011 = ddd.dd, 100 = dd.ddd, 101 = d.dddd, 110 = .dddd
93	005D	Serial Transm. Start Character	Bits 7:0	ASCII Hex Character
94	005E	Serial Transm. Stop Character	Bits 7:0	ASCII Hex Character
95	005F	Modbus Addr.	Bits 7:0	Hex value of Decimal Address from 1-255

READ ONLY (FC03) – Data Type B16

101	0065	Device Type	Bits 7:0	01 = DPM1, 02 = Weight Meter1, 03 = Counter / Timer1, 05 = DPM2, 06 = Weight Meter2, 07 = Counter/Timer2
102	0066	Revision	Bits 7:0	Hex value of Decimal Revision number
103	0067	Overload Value	Bits 7:0	Hex overload value
104	0068	Options	Bits 1:0 Bits 3:2 Bit 5 Bit 6 Bit 7	1 = DC or TC, 2 = RMS, 3 = Load Cell 0 = No Interface, 1 = RS23, 2 = RS485, 3 = BCD 1 = Analog Output Board 1 = Relay Board 1 = Front Panel Lockout

WRITE ONLY (FC10 dec16) – Data Type 2C32

105	0069	Display Data (Hi Word)	Hi word of Remote Data to be displayed.
106	006A	Display Data (Lo Word)	Lo word of Remote Data to be displayed.

12.0 WEIGHT METER INTERNAL REGISTER ADDRESSES FC03 & FC10 (dec16)

Use only odd-numbered starting Register Addresses from 1 to 45 (Dec) and an even number of Registers.

Register Address		Register Name	Data Type	Scaling & Decimal Point
Dec	Hex			
1	0001	Setpoint 1 (Hi word)	2C32	Dec pt. same as displayed.
2	0002	Setpoint 1 (Lo word)	2C32	
3	0003	Setpoint 2 (Hi word)	2C32	Dec pt. same as displayed.
4	0004	Setpoint 2 (Lo word)	2C32	
5	0005	Setpoint 3 (Hi word)	2C32	Dec pt. same as displayed.
6	0006	Setpoint 3 (Lo word)	2C32	
7	0007	Setpoint 4 (Hi word)	2C32	Dec pt. same as displayed.
8	0008	Setpoint 4 (Lo word)	2C32	
9	0009	Scale (Hi word)	2C32	Scale = .00001 x dec value
10	000A	Scale (Lo word)	2C32	of Hi word + Lo word
11	000B	Offset (Hi word)	2C32	Dec pt. same as displayed.
12	000C	Offset (Lo word)	2C32	
17	0011	Lo In (Hi word)	2C32	Uses Dec pt. of input range.
18	0012	Lo In (Lo word)	2C32	
19	0013	Lo Rd (Hi word)	2C32	Dec pt. same as displayed.
20	0014	Lo Rd (Lo word)	2C32	
21	0015	Hi In (Hi word)	2C32	Uses Dec pt. of input range.
22	0016	Hi In (Lo word)	2C32	
23	0017	Hi Rd (Hi word)	2C32	Dec pt. same as displayed.
24	0018	Hi Rd (Lo word)	2C32	
25	0019	Tare (Hi word)	2C32	Dec pt. same as displayed.
26	001A	Tare (Lo word)	2C32	
33	0021	Dribble 1 (Hi word)	M32	Dec pt. same as displayed.
34	0022	Dribble 1 (Lo word)	M32	
35	0023	Dribble 2 (Hi word)	M32	Dec pt. same as displayed.
36	0024	Dribble 2 (Lo word)	M32	
37	0025	Dribble 3 (Hi word)	M32	Dec pt. same as displayed.
38	0026	Dribble 3 (Lo word)	M32	
39	0027	Dribble 4 (Hi word)	M32	Dec pt. same as displayed.
40	0028	Dribble 4 (Lo word)	M32	
41	0029	Analog Lo (Hi word)	2C32	Dec pt. same as displayed.
42	002A	Analog Lo (Lo word)	2C32	
43	002B	Analog Hi (Hi word)	2C32	Dec pt. same as displayed.
44	002C	Analog Hi (Lo word)	2C32	

For the following, use any starting Register Address and any number of Registers. The Data Type is B16, except for FC10 dec 16, where the data type is 2C32.

Register Address		Register Name	Bit Significance		
Dec	Hex				
65	0041	Alarm Config 1	Bit 0	0 = AL1 Hi Active	1 = Lo Active
			Bit 1	0 = AL1 Enabled,	1 = Disabled
			Bit 2	0 = AL2 Hi Active	1 = Lo Active
			Bit 3	0 = AL2 Enabled	1 = Disabled
			Bit 4	0 = AL1 Non-Latched	1 = Latched
			Bit 5	0 = AL2 Non-Latched	1 = Latched
			Bit 6	0 = Relay1 Active On	1 = Off
			Bit 7	0 = Relay2 Active On	1 = Off
66	0042	Alarm Config 2	Bits 2:0 # Readings before Alarms 1 & 2. 000 = 1, 001 = 2, 010 = 4, 011 = 8, 100 = 16, 101 = 32, 110 = 64, 111 = 128		
			Bits 4:3 Setpoint Compare Source		
			Bit 3	AL1 0 = Net	1 = Gross
			Bit 4	AL2 0 = Net	1 = Gross
67	0043	Alarm Config 3 (Alarms 3 & 4 are planned developments)	Bit 0	0 = AL3 Hi Active	1 = Lo Active
			Bit 1	0 = AL3 Enabled	1 = Disabled
			Bit 2	0 = AL4 Hi Active	1 = Lo Active
			Bit 3	0 = AL4 Enabled	1 = Disabled
			Bit 4	0 = AL3 Non-Latched	1 = Latched
			Bit 5	0 = AL4 Non-Latched	1 = Latched
			Bit 6	0 = Relay3 Active On	1 = Off
			Bit 7	0 = Relay4 Active On	1 = Off
68	0044	Alarm Config 4 (Alarms 3 & 4 are planned developments)	Bits 2:0 = # Readings before Alarms 3 & 4. 000 = 1, 001 = 2, 010 = 4, 011 = 8, 100 = 16, 101 = 32 110 = 64 111 = 128		
			Bit 3	AL3 0 = Net	1 = Gross
			Bit 4	AL4 0 = Net	1 = Gross
69	0045	Input Type	Lo Byte Hex value		
			60-64	DC 0.2V, 2V, 20V, 200V, 660V	
			70-73	DC 2 mA, 20 mA, 200 mA, 5A	
			A0-A2	Ratio 0.2V, 2V, 20V, 200V, 660V	
			C0-C4	Load Cell 20, 50, 100, 250, 500 mV	
			D0-D4	Microvolts 20, 50, 100, 250, 500 mV	
70	0046	Setup	Bits 3:0	Ctrl In 1	Ctrl In 2
			Hex 0	MReset	MHold
			Hex 1	FReset	Pk, Vy
			Hex 2	MHold	Pk, Vy
				Both Reset	Cold (M = Meter)
					Cold (F = Function)
					Func (D = Display)

			Hex 3 MHold Tare Tare Hex 4 Pk, Vy Tare Func Hex 5 MReset Tare Cold Hex 6 FReset Tare Cold Hex 7 TReset Tare Cold Hex 8 DBlank Tare Cold Hex 9 MReset DBlank Cold Hex A FReset DBlank Cold Hex B DItem2 Tare Tare Hex C Valley Peak Func Hex D MReset DItem2 Cold Hex E FReset DItem2 Cold Hex F MHold DItem2 Cold Bits 5:4 Hex 00 Scale using Scale, Offset Hex 01 Scale using Coordinates of 2 Points Hex 10 Scale using Reading Coordinates Bit 7 0 = 60 Hz, 1 = 50 Hz (Bit 6 = Spare)
71	0047	Filter	Bits 3:0 Filtering Hex 0 = Auto Filter, 1 = Batch 16, 2-9 = Moving Avg, 2 = .08S, 3 = .15S, 4 = .3S, 5 = .6S, 6 = 1.2S, 7 = 2.4S, 8 = 4.8S, 9 = 9.6S, A = Unfiltered Bit 4 Hex 0 = Low Adaptive, 1 = High Adaptive Bit 5 Hex 0 = Display Batch of 16, 1 = Display Filtered Bit 6 Hex 0 = Peak of Unfiltered, 1 = Peak of Filtered Bit 7 Hex 0 = Alarm source Unfiltered, 1 = Filtered
72	0048	Options	Do Not Use. Serial Config 1,2,3 do not pertain to Modbus parameters, only Serial Config 4.
73	0049	Serial Config 1	Bits 3:0 Time between Continuous Serial Outputs Hex 0=.017S, 1=.28S, 2=.57S, 3=1.1S, 4=2.3S, 5=4.5S, 6=9.1S, 7=18.1S, 8=36.3S, 9=1M13S, A=2M25S, B=4M50S, C=9M40S, D=19M20S, E=38M41S, F=77M21S Bits 6:4 Baud Rate 000 = 300, 001 = 600, 010 = 1200, 011 = 2400, 100 = 4800, 101 = 9600, 110 = 19200 Bit 7 0 = Send Unfiltered value, 1 = Send Filtered Val

74	004A	Serial Config 2	<p>Bits 4:0 Meter Serial Address (0-31) [Non-Modbus] Hex 0 = Broadcast (01 = 1 to 0A = 10), 0F = 15, 10 = 16, 1F = 31</p> <p>Bit 5 0 = Continuous Mode, 1 = Command Mode</p> <p>Bit 6 0 = No Alarm data w/ readings, 1 = Alarm data</p> <p>Bit 7 0 = No LF following CR, 1 = LF following CR</p>
75	004B	Serial Config 3	<p>Bits 2:0 Data sent in serial output 0 = Net + Gross, 1 = Net, 2 = Gross, 3 = Peak 4 = Net + Gross + Peak, 5 = Valley, 6 = Net + Gross + Peak + Valley</p> <p>Bit 3 0 = Termination chars at end of all items 1 = " " at end of each item</p> <p>Bit 4 0 = Non-latching, RTS 1 = Latching RTS</p> <p>Bit 5 0 = Normal continuous serial transmission 1 = Special Start & Stop characters</p> <p>Bit 6 0 = Full Duplex, 1 = Half Duplex</p>
76	004C	Serial Config 4	<p>Bits 1:0 00 = No Parity, 01 = Odd Parity, 11 = Even Parity</p> <p>Bits 3:2 00 = Custom ASCII, 01 = Modbus RTU, 10 = Modbus ASCII</p> <p>Bits 5:4 Modbus ASCII Gap Timeout 00 = 1S, 01 = 3S, 10 = 5S, 11 = 10S</p>
77	004D	Config	<p>Bit 0 0 = Linear Curve 1 = Custom Curve</p> <p>Bit 1 0 = Peak of Net, 1 = Peak of Gross</p> <p>Bits 2 0 = Dribble enabled, 1 = Dribble disabled</p> <p>Bits 4:3 Peak button display response 00 = Peak, 01 = Valley, 10 = Peak then Valley</p> <p>Bits 7:5 000 = Not Rate, 001 = Rate x 0.1, 010 = Rate x 1, 011 = Rate x 10, 100 = Rate x 100, 101 = Rate x 1000, 110 = Rate x 10000</p>
78	004E	Lockout 1	<p>0 = Enabled, 1 = Locked out</p> <p>Bit 0 Count</p> <p>Bit 1 Setup</p> <p>Bit 2 Input Type</p> <p>Bit 3 Change Display Item #</p> <p>Bit 4 Tare</p> <p>Bit 5 Offset, Low Read, Hi Read</p> <p>Bit 6 Scale, Lo in, Hi in</p> <p>Bit 7 Filter</p>

79	004F	Lockout 2	Bit 0 Bit 1 Bit 2 Bit 3 Bit 4 Bit 5 Bit 6 Bit 7	Serial Comm Config Analog Out Scaling Alarm Setpoint Programming Alarm Config Front Panel Meter Reset Front Panel Function Reset View Setpoints View Peak
81	0051	Setup 1	Bits 1:0	0 = Reset to Net, No Dummy Zero 1 = Reset to Net, Dummy Zero 2 = Reset to Gross, No Dummy Zero 3 = Reset to Gross, Dummy Zero
82	0052	Analog Output Setup	Bit 0 Bit 1 Bit 2	0 = Analog Out Source Unfiltered , 1 = Filtered 0 = Current Output, 1 = Voltage Output 0 = Net Value, 1 = Gross Value
83	0057	Count 1	Bits 3:0	Auto-Zero Range in +/- counts 0 = 0 (No Auto-Zero) , 1-9 = 1-9 counts resp.
87	0057	System Decimal Point	Bits 2:0	001 = ddddd., 010 = dddd.d, 011 = ddd.dd, 100 = dd.ddd, 101 = d.dddd, 110 = .dddd
93	005D	Serial Transm. Start Character	Bits 7:0	ASCII Hex Character
94	005E	Serial Transm. Stop Character	Bits 7:0	ASCII Hex Character
95	005F	Modbus Addr.	Bits 7:0	Hex value of Decimal Address from 1-255

READ ONLY (FC03) – Data Type B16

101	0065	Device Type	Bits 7:0	01 = DPM1, 02 = Weight Meter1, 03 = Counter / Timer1, 05 = DPM2, 06 = Weight Meter2, 07 = Counter/Timer2
102	0066	Revision	Bits 7:0	Hex value of Decimal Revision number
103	0067	Overload Value	Bits 7:0	Hex overload value
104	0068	Sig Conditioner	Bits 7:0	1 = DC or TC, 2 = RMS, 3 = Load Cell

WRITE ONLY (FC10 dec16) – Data Type 2C32

105	0069	Display Data (Hi Word)		Hi word of Remote Data to be displayed.
106	006A	Display Data (Lo Word)		Lo word of Remote Data to be displayed.

13.0 COUNTER / TIMER REGISTER ADDRESSES FC03 & FC10 (dec16)

Use only odd-numbered starting Register Addresses from 1 to 43 (Dec) and an even number of Registers. Dec Pt same as System Dec Pt (Displayed DP, Dec Address 87, Hex Address 57H), except as noted.

Register Address		Register Name	Data Type	Scaling & Decimal Point
Dec	Hex			
1	0001	Setpoint 1 (Hi word)	2C32	Dec pt. same as displayed.
2	0002	Setpoint 1 (Lo word)	2C32	
3	0003	Setpoint 2 (Hi word)	2C32	Dec pt. same as displayed.
4	0004	Setpoint 2 (Lo word)	2C32	
5	0005	Setpoint 3 (Hi word)	2C32	Dec pt. same as displayed.
6	0006	Setpoint 3 (Lo word)	2C32	
7	0007	Setpoint 4 (Hi word)	2C32	Dec pt. same as displayed.
8	0008	Setpoint 4 (Lo word)	2C32	
9	0009	Scale 1Y (Hi word)	M32	Scale = .00001 x dec value
10	000A	Scale 1Y (Lo word)	M32	of (Hi word + Lo word)*
11	000B	Offset 1 (Hi word)	2C32	Dec pt. same as displayed.
12	000C	Offset 1 (Lo word)	2C32	
13	000D	Scale 2Y (Hi word)	M32	Scale = .00001 x dec value
14	000E	Scale 2Y (Lo word)	M32	of (Hi word + Lo word)*
15	000F	Offset 2 (Hi word)	2C32	Dec pt. same as displayed.
16	0010	Offset 2 (Lo word)	2C32	
17	0011	Lo In 1 (Hi word)	2C24	Lo In = .00001 x dec value
18	0012	Lo In 1 (Lo word)	2C24	of (Hi word + Lo word)*
19	0013	Lo Rd 1 (Hi word)	2C32	Dec pt. same as displayed.
20	0014	Lo Rd 1 (Lo word)	2C32	
21	0015	Hi In 1 (Hi word)	2C24	Hi In = .00001 x dec value
22	0016	Hi In 1 (Lo word)	2C24	of (Hi word + Lo word)*
23	0017	Hi Rd 1 (Hi word)	2C32	Dec pt. same as displayed.
24	0018	Hi Rd 1 (Lo word)	2C32	
25	0019	Lo In 2 (Hi word)	2C24	Lo In = .00001 x dec value
26	001A	Lo In 2 (Lo word)	2C24	of (Hi word + Lo word)*
27	001B	Lo Rd 2 (Hi word)	2C32	Dec pt. same as displayed.
28	001C	Lo Rd 2 (Lo word)	2C32	
29	001D	Hi In 2 (Hi word)	2C24	Hi In = .00001 x dec value
30	001E	Hi In 2 (Lo word)	2C24	of (Hi word + Lo word)*
31	001F	Hi Rd 2 (Hi word)	2C32	Dec pt. same as displayed.
32	0020	Hi Rd 2 (Lo word)	2C32	
33	0021	Deviation 1 (Hi word)	M32	Dec pt. same as displayed.
34	0022	Deviation 1 (Lo word)	M32	

35	0023	Deviation 2 (Hi word)	M32	Dec pt. same as displayed.
36	0024	Deviation 2 (Lo word)	M32	
37	0025	Deviation 3 (Hi word)	M32	Dec pt. same as displayed.
38	0026	Deviation 3 (Lo word)	M32	
39	0027	Deviation 4 (Hi word)	M32	Dec pt. same as displayed.
40	0028	Deviation 4 Lo word)	M32	
41	0029	Analog Lo (Hi word)	2C32	Dec pt. same as displayed.
42	002A	Analog Lo (Lo word)	2C32	
43	002B	Analog Hi (Hi word)	2C32	Dec pt. same as displayed.
44	002C	Analog Hi (Lo word)	2C32	

* Max Value = 21,474.1

For the following, use any starting Register Addresses and any number of Registers.

Register Address		Register Name	Data Type	Scaling & Decimal Point
Dec	Hex			
49	0031	GateTime	M16	1-19999 (4E1F) Dec Pt =XXX.XX
50	0032	TimeOut	M16	1-19999 (4E1F) Dec Pt =XX.XXX
51	0033	Pulses	M16	1-59999 (4E1F) Dec Pt =XXXXX.
52	0034	Total B (Hi word)	M48	
53	0035	Total B (Mid word)	M48	
54	0036	Total B (Lo word)	M48	
55	0037	Total A (Hi word)	M48	
56	0038	Total A (Mid word)	M48	
57	0039	Total A (Lo word)	M48	

The Data Type is B16, except for FC10 dec 16, where the data type is 2C32.

Register Address		Register Name	Bit Significance	
Dec	Hex			
65	0041	Alarm Config 1	Bit 0	0 = AL1 Hi Active 1 = Lo Active
			Bit 1	0 = AL1 Enabled, 1 = Disabled
			Bit 2	0 = AL2 Hi Active 1 = Lo Active
			Bit 3	0 = AL2 Enabled 1 = Disabled
			Bit 4	0 = AL1 Non-Latched 1 = Latched
			Bit 5	0 = AL2 Non-Latched 1 = Latched
			Bit 6	0 = Relay1 Active On 1 = Off
			Bit 7	0 = Relay2 Active On 1 = Off
66	0042	Alarm Config 2	Bits 2:0	# Readings before Alarms 1 & 2. 000 = 1, 001 = 2, 010 = 4, 011 = 8, 100 = 16, 101 = 32, 110 = 64, 111 = 128
			Bits 4:3	Setpoint Compare Source

			Bit 3 AL1 0 = Deviation 1 = Hysteresis Bit 4 AL2 0 = Deviation 1 = Hysteresis Bit 5 0 = Deviation in Menu 1 = Omitted
67	0043	Alarm Config 3 (Alarms 3 & 4 are planned developments)	Bit 0 0 = AL3 Hi Active 1 = Lo Active Bit 1 0 = AL3 Enabled 1 = Disabled Bit 2 0 = AL4 Hi Active 1 = Lo Active Bit 3 0 = AL4 Enabled 1 = Disabled Bit 4 0 = AL3 Non-Latched 1 = Latched Bit 5 0 = AL4 Non-Latched 1 = Latched Bit 6 0 = Relay3 Active On 1 = Off Bit 7 0 = Relay4 Active On 1 = Off
68	0044	Alarm Config 4 (Alarms 3 & 4 are planned developments)	Bits 2:0 = # Readings before Alarms 3 & 4. 000 = 1, 001 = 2, 010 = 4, 011 = 8, 100 = 16, 101 = 32 110 = 64 111 = 128 Bit 3 AL3 0 = Deviation 1 = Hysteresis Bit 4 AL4 0 = Deviation 1 = Hysteresis Bit 5 0 = Deviation in Menu 1 = Omitted
69	0045	Input Type	00-0F 00 = Rate A&B, 01 = AOnly, 02 = Batch, 03 = A_Atot, 05 = A_Btot, 0B = A+B, 0C = A-B, 0D = A*B, 0E = A/B, 0F = A/B-1 10-11 10 = Period A&B, 11 = AOnly 1B-1E 1B = A+B, 1C = A-B, 1D = A*B, 1E = A/B 20-21 20 = Total A&B, 21 = AOnly 24-2E 24 = A-B_ud, 26 = Burst=26, 27 = B_Arat, 29 = A_Bud, 2A = A_Binh, 2B = A+B, 2C = A-B, 2D = A*B, 2E = A/B 41 41 = Time Interval A to B 50-51 50 = Stopwatch A to A, 51 = Stopwatch A to B 61-62 61 = Phase 0-360 62 = Phase -180 to +180 71 71 = Duty Cycle A to B XY V-to F Signal Conditioner if X = 8, 9 or A 81 = V-to-F, 4-20 mA input, Aonly 82 = V-to-F, 4-20 mA in, Batch 83 = V-to-F, 4-20 mA in, A_Atot 8F = V-to-F, 4-20 mA in, 1/A 91 = V-to-F, 0-1 mA in, Aonly 92 = V-to-F, 0-1 mA in, Batch 93 = V-to-F, 0-1 mA in, A_Atot 9F = V-to-F, 0-1 mA in, 1/A A1 = V-to-F, 0-10V in, Aonly

			<p>A2 = V-to-F, 0-10V in, Batch A3 = V-to-F, 0-10V in, A_Atot AF = V-to-F, 0-10V in, 1/A C0-C1 C0 = Quadrature Total C1 = Quadrature Rate=C1</p>
70	0046	Setup	<p>Bits 3:0 Ctrl In 1 Ctrl In 2 Both Reset</p> <p>Hex 0 MReset FReset Cold (M = Meter) Hex 1 MReset MHold Cold (F = Function) Hex 2 MReset Pk, Vy Cold (D = Display) Hex 3 MReset ExtGate Cold Hex 4 FReset MHold Func Hex 5 Valley Peak Func Hex 6 FReset ExtGate Cold Hex 7 MHold Pk, Vy Func Hex 8 MHold ExtGate Cold Hex 9 Pk, Vy ExtGate NoAction Hex A MReset DBlank Cold Hex B FReset DBlank Cold Hex C MHold DBlank Cold Hex D Pk, Vy DBlank Func Hex E DBlank ExtGate Cold Hex E Item2 Item3 Item 1 = Neither</p> <p>Bit 4 0 = Scale2 using Scale, Offset 1 = Scale2 using Coordinates of 2 Points</p> <p>Bit 5 0 = Scale1 using Scale, Offset 1 = Scale1 using Coordinates of 2 Points</p> <p>Bit 6 0 = Blank leading zeros 1 = Display leading zeros</p> <p>Bit 7 0 = Zero Total upon Power-On 1 = Restore Total upon Power-On</p>
71	0047	Filter	<p>Bits 2:0 1 = .1S, 2 = .2S, 3 = .4S, 4=.8S, 5=1.6S, 6 = 3.2S, 7=6.4S</p> <p>Bit 3 0 = Low Adaptive, 1 =High Adaptive</p> <p>Bit 4 0 = Display Unfiltered, 1=Display Filtered</p> <p>Bit 5 0 = Peak, Valley of Unfiltered 1 = Peak,Valley of Filtered</p> <p>Bit 6 0 = Adaptive Filter, 1 = Conventional Filter</p>
72	0048	Options	Do Not Use. Serial Config 1,2,3 do not pertain to Modbus parameters, only Serial Config 4.
73	0049	Serial Config 1	<p>Bits 3:0 Time between Continuous Serial Outputs Hex 0=.017S, 1=.28S, 2=.57S, 3=1.1S, 4=2.3S, 5=4.5S, 6=9.1S, 7=18.1S, 8=36.3S, 9=1M13S,</p>

			<p>A=2M25S, B=4M50S, C=9M40S, D=19M20S, E=38M41S, F=77M21S</p> <p>Bits 6:4 Baud Rate 000 = 300, 001 = 600, 010 = 1200, 011 = 2400, 100 = 4800, 101 = 9600, 110 = 19200</p> <p>Bit 7 0 = Send Unfiltered value, 1 = Send Filtered Val</p>
74	004A	Serial Config 2	<p>Bits 4:0 Meter Serial Address (0-31) [Non-Modbus] Hex 0 = Broadcast (01 = 1 to 0A = 10), 0F = 15, 10 = 16, 1F = 31</p> <p>Bit 5 0 = Continuous Mode, 1 = Command Mode</p> <p>Bit 6 0 = No Alarm data w/ readings, 1 = Alarm data</p> <p>Bit 7 0 = No LF following CR, 1 = LF following CR</p>
75	004B	Serial Config 3	<p>Bits 2:0 Data sent in serial output 0 = All active Items, 1 = Item1, 2 = Item2, 3 = Item3, 4 = Peak, 5 = All active Items+ Peak, 6 = Valley, 7 = All active Items + Peak + Valley</p> <p>Bit 3 0 = Termination chars at end of all items 1 = " " at end of each item</p> <p>Bit 4 0 = Non-latching RTS, 1 = Latching RTS</p> <p>Bit 5 0 = "*" Recognition Character 1 = Custom Recognition Character</p> <p>Bit 6 0 = No Serial Start / Stop Characters 1 = Start / Stop Characters</p> <p>Bit 7 0 = Full Duplex, 1 = Half Duplex</p>
76	004C	Serial Config 4	<p>Bits 1:0 00 = No Parity, 01 = Odd Parity, 11 = Even Parity</p> <p>Bits 3:2 00 = Custom ASCII, 01 = Modbus RTU, 10 = Modbus ASCII</p> <p>Bits 5:4 Modbus ASCII Gap Timeout 00 = 1S, 01 = 3S, 10 = 5S, 11 = 10S</p>

77	004D	Config	<p>Bit 0 0 = VF Batch, Atot zero cutoff 1 = Allow negative values</p> <p>Bit 1 0 = Calculate Rate value 1 = Calculate Square Root of Rate</p> <p>Bits 3:2 00 = Basic Counter, 01 = Extended Counter 10 = Custom Curve #1 11=Custom Curve #2 (if V-to-F)</p> <p>Bits 7:4 0 = Exponential Overload 1 = 999999 Overload 2 = One Right Hand Dummy Zero 3 = Two Right Hand Dummy Zeros 4 = Clock Time in Seconds 5 = Clock Time in HH.MM.SS Format 6 = Remote Display, HKL Command 7 = Remote Display, Value 8 = 1st Value in String 9 = 2nd Value in String A = 3rd Value in String B = 4th Value in String C = Remote Display using Start, Stop, Skip, Show Characters</p>
78	004E	Lockout 1	<p>0 = Enabled, 1 = Locked out</p> <p>Bit 0 Filter</p> <p>Bit 1 Gate Time, Timeout, Batch, Setup</p> <p>Bit 2 Setup, Config, Display Number</p> <p>Bit 3 Input Type</p> <p>Bit 4 Setpoint Programming</p> <p>Bit 5 Alarm Config, Deviation, Hysteresis</p> <p>Bit 6 Scale, Offset, Resolution, 2 Coordinates</p> <p>Bit 7 Slope, Decimal Points</p>
79	004F	Lockout 2	<p>0 = Enabled, 1 = Locked out</p> <p>Bit 0 Change Item# displayed</p> <p>Bit 1 Calibration, Loc 3 & Loc 4</p> <p>Bit 2 Serial Config</p> <p>Bit 3 Analog Out Scaling & Setup</p> <p>Bit 4 Front Panel Meter Reset</p> <p>Bit 5 FP Function Reset</p> <p>Bit 6 View Setpoints</p> <p>Bit 7 View Peak</p>

81	0051	Alarm Source	Bits 1:0 Setpoint 2 Bits 3:2 Setpoint 1 Bits 5:4 Setpoint 4 Bits 7:6 Setpoint 3 For each Setpoint: 00 = Filtered Item, 01 = Item1, 10 = Item2, 11 = Item3
82	0052	Analog Output Setup	Bits1:0 0 = Filtered Item, 1 = Item1, 2 = Item2, 3 = Item3 Bit 2 0 = Current Output, 1 = Voltage Output
83	0057	Scale Multiplier	Bits 3:0 Scale1 Multiplier Bits 7:4 Scale2 Multiplier 0 = .00001, 1 = .0001, 2 = .001, 3 = .01, 4 = .1, 5 = 1, 6 = 10, 7 = 100, 8 = 1000, 9 = 10000, A = 100000
84	0054	Trigger Slope	Bit 0 0 = Positive Slope, B Input 1 = Negative Slope, B Input Bit 1 0 = Positive Slope, A Input 1 = Negative Slope, A Input
85	0055	Display Item	Bits 1:0 1 = Item1, 2 = Item2, 3 = Item3 Bits 3:2 Display Response to Peak Button: 00 = Peak, 01 = Valley, 10 = Peak then Valley
86	0056	Resolution	Bits 3:0 0 = .00001, 1 = .0001, 2 = .001, 3 = .01, 4 = .1, 5 = 1, 6 = 10, 7 = 100, 8 = 1000, 9 = 10000, A = 100000
87	0057	System Decimal Point	Bits 3:0 DecPt1 Bits 7:4 DecPt2 1 = ddddd., 2 = ddddd.d, 3 = dddd.dd, 4 = ddd.ddd, 5 = dd.dddd, 6 = d.ddddd
Special Characters			
88	0058	Recognition	Bits 7:0 ASCII Hex Character
89	0059	Remote Start	Bits 7:0 ASCII Hex Character
90	005A	Remote Stop	Bits 7:0 ASCII Hex Character
91	005B	Remote Skip	Bits 7:0 ASCII Hex Character
92	005C	Remote Show	Bits 7:0 ASCII Hex Character
93	005D	Ser Trans Start	Bits 7:0 ASCII Hex Character
94	005E	Ser Trans Stop	Bits 7:0 ASCII Hex Character
95	005F	Modbus Add.	Bits 7:0 Hex Value of Decimal Address 1-255

READ ONLY (FC03) – Data Type B16

101	0065	Device Type	Bits 7:0 01 = DPM1, 02 = Weight Meter1, 03 = Counter / Timer1, 05 = DPM2, 06 = Weight Meter2, 07 = Counter/Timer2
102	0066	Revision	Bits 7:0 Hex value of Decimal Revision number
103	0067	Overload Value	Bits 7:0 Hex overload value
104	0068	Sig Conditioner	Bits 7:0 1 = DC or TC, 2 = RMS, 3 = Load Cell

WRITE ONLY (FC10 dec16) – Data Type 2C32

105	0069	Display Data	Hi word of Remote Data to be displayed.
106	006A	Display Data	Lo word of Remote Data to be displayed.
107	006B	Data to Item3	Hi word of Remote Data to be applied to Item3
108	006C	Data to Item3	Lo word of Remote Data to be applied to Item3
109	006D	Data to Both	Hi word of Remote Data to be displayed & applied to Item3.
110	006E	Data to Both	Lo word of Remote Data to be displayed & applied to Item3.

Please see the description at the end of Section 8.0 for comparing the Remote Data to the Relay Setpoints or using it as the source for setting the Analog Output.

25. WARRANTY

Electro-Numerics, Inc. warrants these products to be free of defects in materials and workmanship for two years from the date of shipment to the original customer. This warranty may be considered as unconditional provided that, in the opinion of Electro-Numerics, the equipment has not been mechanically, environmentally, or electrically abused and has been installed, maintained and operated within the limits of rated or normal usage. Defective products must be sent, transportation charges prepaid, with notice of the defect, to our plant in Temecula CA.

This warranty is limited, at the option of Electro-Numerics, Inc. to repair, replacement, or an appropriate credit adjustment not to exceed the original equipment sales price. All warranty freight charges are F.O.B. our plant, Temecula, CA.

Electro-Numerics assumes no responsibility in connection with the sale of its products beyond that stated above and is not responsible for any incidental or consequential loss or damage which might result from a failure of any Electro-Numerics, Inc. product.



ELECTRO-NUMERICS, INC.

42213 Sarah Way, Temecula CA 92590

Tel: **800-854-8530** (U.S.A.)

Tel: 951-699-2437, Fax: 951-695-7246

Web Site: www.ElectroNumerics.com