

Custom ASCII Protocol SERIAL COMMUNICATIONS MANUAL

For Series B Digital Panel Meters,
Counters & Timers



ELECTRO-NUMERICS, INC.

1. TABLE OF CONTENTS

1.	TABLE OF CONTENTS	2
2.	INTRODUCTION, CUSTOM ASCII SERIAL PROTOCOL	3
3.	JUMPER SETTINGS & FIELD WIRING FOR SERIAL COMMUNICATIONS.....	4
4.	INSTRUMENT SETUP SOFTWARE	7
5.	FRONT PANEL SETUP, SERIAL COMMUNICATIONS	9
6.	RS232 & RS485 COMMUNICATION PROTOCOLS.....	13
7.	CONTINUOUS MODE.....	15
8.	COMMAND MODE.....	17
9.	APPENDIX A: DPM MEMORY ADDRESSES AND DATA DEFINITIONS.....	27
10.	APPENDIX B: COUNTER / TIMER MEMORY ADDRESSES AND DATA DEFINITIONS.....	35
11.	APPENDIX C: WEIGHT METER MEMORY ADDRESSES AND DATA DEFINITIONS.....	44
12.	RECOMMENDED SUPPLIERS	53
13.	WARRANTY	56

2. INTRODUCTION, CUSTOM ASCII SERIAL PROTOCOL

This manual applies to our programmable digital panel meters, counters and timers with Series 2 firmware. Before applying this manual to your device, verify that the label states “Series 2.”

The Custom ASCII Protocol, which is the subject of this manual, is a simple serial communications protocol which is optimized for use with Series 2 programmable digital panel meters, counters and timers. It is compatible with RS232 and RS485 signals. It supports point-to-point and multipoint (or multidrop) communications, with addressing of up to 31 devices on the same RS485 serial data line.

Digital panel meters, counters and timers require a plug-in option board for serial communications. This can be an RS232 board, RS485 board, or RS485 Modbus board. The RS232 and RS485 Modbus boards are electrically equivalent, but the RS485 board uses RJ11 connectors, while the RS485 Modbus board uses RJ45 connectors. The two RJ11 or RJ45 connectors are wired in parallel to allow daisy chaining with no need for a hub. One of the jacks is equipped with two indicator LEDs.

The Modbus Protocol is a software-selectable alternative to the Custom ASCII Protocol and can be used with RS232 or RS485 signal levels. It is an industry standard which allows devices by different manufacturers to be digitally addressed on the same RS485 serial data line. However, it is substantially more complex than the Custom ASCII Protocol. For additional information, please refer to the separate Modbus Protocol Communications Manual.

3. JUMPER SETTINGS & FIELD WIRING FOR SERIAL COMMUNICATIONS

3.1 SAFETY WARNINGS



Digital panel meters, counters and timers may be powered with AC (mains) from 95-240V ac $\pm 10\%$ or 95-300V dc with the high voltage power supply option, or 10-34V ac $\pm 10\%$ or 10-48 Vdc with the low voltage power supply option. To avoid the possibility of electrical shock or damaging short circuits, always unplug the device before opening the case. Please refer to the respective device manuals for full safety information and instruction on how to open the case. Signal wiring changes external to the case can be made safely while the units are under power.

3.2 CONNECTION OF METERS, COUNTERS & TIMERS TO COMPUTER

RS232 INTERFACE Computer

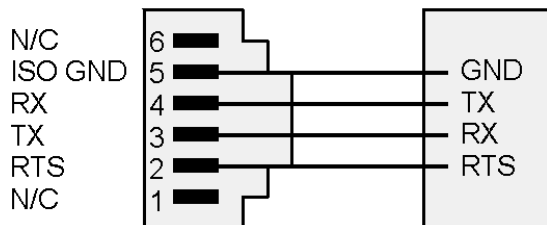

RS485 INTERFACE - FULL DUPLEX

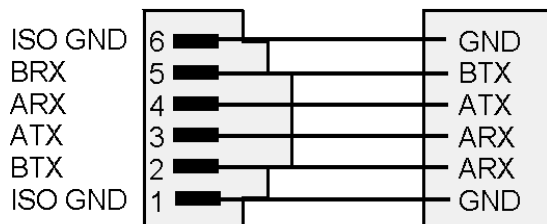

RS485 INTERFACE - HALF DUPLEX

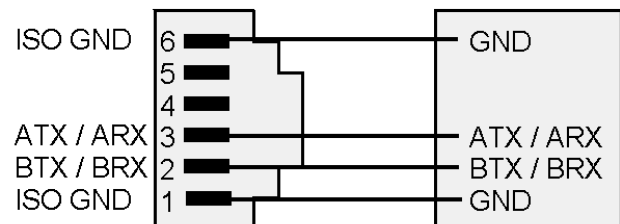

RS485-MODBUS - FULL DUPLEX

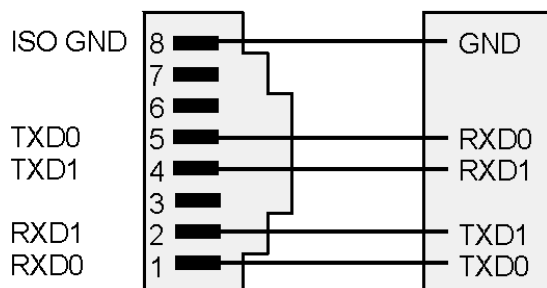

RS485-MODBUS - HALF DUPLEX

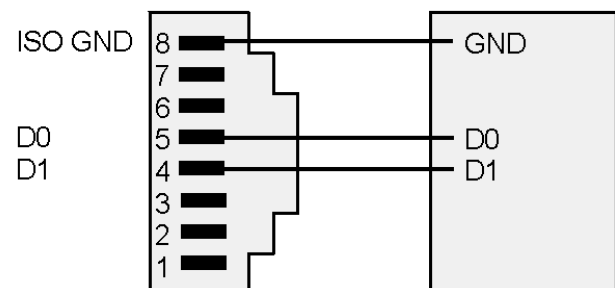

Another alternative for RS-485 is to use an RS-232 to RS-485 converter that plugs into the computer RS-232 receptacle external to the computer and is powered from a +9V DC wall plug-in adapter. One such unit is the B & B Electronics Model 4850T9L.

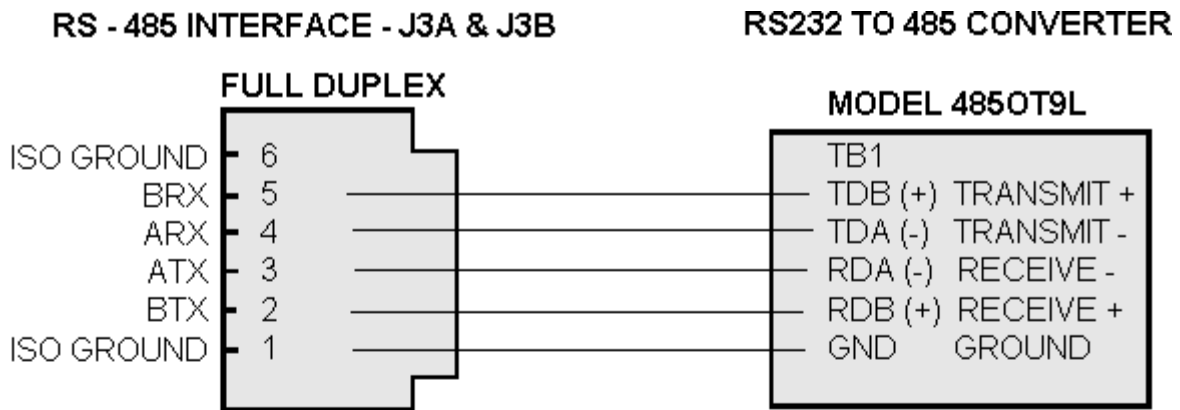

SWITCH SETTINGS FOR MODEL 4850T9L

Baud rate

4800 Baud	-	S1-ON,	S2-OFF	S3-OFF	S4-OFF
9600 Baud	-	S1-OFF,	S2-ON	S3-OFF	S4-OFF
19200 Baud	-	S1-OFF,	S2-OFF	S3-ON	S4-OFF

Echo - S5-OFF

2-wire/4-wire - S6-OFF, S7-OFF

Termination - S8-OFF

Driver Control - JP1-Jumper on SD

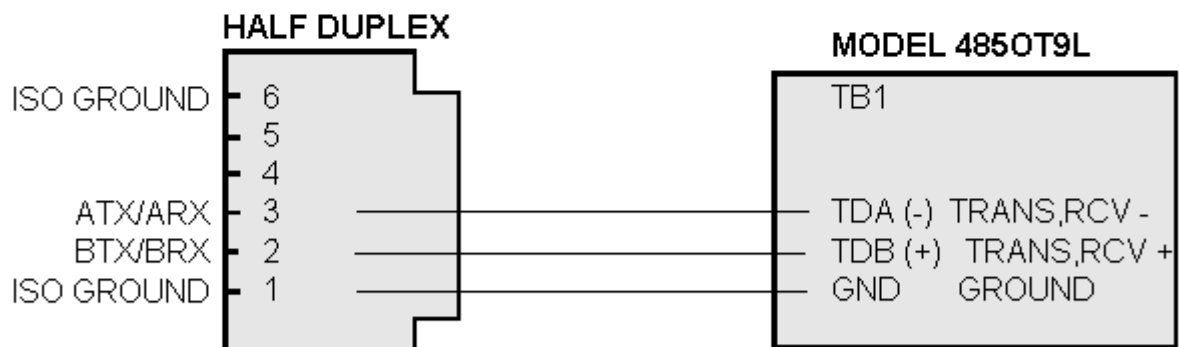

SWITCH SETTINGS FOR MODEL 4850T9L

Baud rate

4800 Baud	-	S1-ON,	S2-OFF	S3-OFF	S4-OFF
9600 Baud	-	S1-OFF,	S2-ON	S3-OFF	S4-OFF
19200 Baud	-	S1-OFF,	S2-OFF	S3-ON	S4-OFF

Echo - S5-ON

2-wire/4-wire - S6-ON, S7-ON

Termination - S8-OFF

Driver Control - JP1-Jumper on SD

3.4 JUMPERS SETTINGS OF METERS, COUNTERS & TIMERS

RS232 Board

- g** Normal operation.
- h** Slave display operation to RS232 output of another meter.
- J** Pull-up resistor on RTS line.

Note: The RS232 board is shipped standard with jumpers g and j installed.

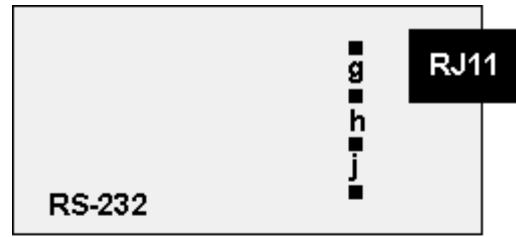

RS485 and RS485-Modbus Boards

Full Duplex Operation

- b & e** These bias jumpers should be installed on 1 (and only 1) meter.
- a & d** Installed on last meter in line with long cable runs.

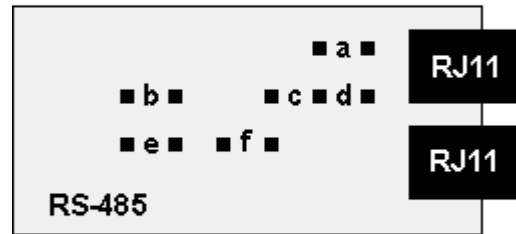

Half Duplex Operation

- b & e** Bias jumpers installed on 1 board.
- c & f** Installed for half duplex operation. installed on last meter in line with long cable runs.

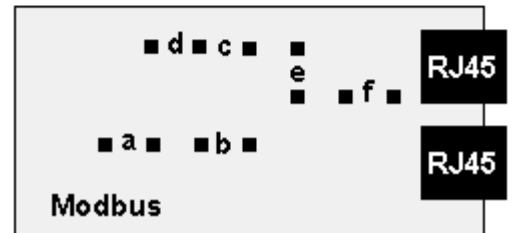

Note: RS485 and RS485 Modbus boards are shipped standard with no jumpers installed.

4. INSTRUMENT SETUP SOFTWARE

4.1 OVERVIEW

The digital panel meters, counters and timers covered by this manual are easily programmed via their serial port using Windows-based **Instrument Setup (IS)** software, which provides a graphical user interface and is available at no charge. This software allows uploading, editing, downloading and saving of setup data, execution of commands under computer control, listing, plotting and graphing of data, and computer prompted calibration. Digital panel meters, counters and timers can also be programmed via their 4-key front panel as explained in their respective manuals; however, front panel programming is not recommended when serial communications are available.

4.2 INSTRUMENT SETUP SOFTWARE INSTALLATION FROM CD ROM

Insert the CD ROM into your PC. The CD is self-booting and will present you with a menu of choices. Click on "Install Instrument Setup Software" and follow the prompts.

4.3 GETTING STARTED WITH IS SOFTWARE

To launch IS software, press *Start* => *Programs* => *IS64* => *IS2*. Click on your device type. The program will temporarily set the selected COM port to the selected baud rate, protocol, and parity. Once communications have been established, click on *Main Menu*.

The best way to learn IS software is to experiment with it. From the Main Menu, click on *Get Setup* to retrieve (or get) the existing setup data from your device. Click on *View* => *Setup* to bring up screens which allow you to edit the setup file using pull-down menus and other selection tools. You can save your file to disk by clicking on *File* => *Save Setup*. You can download (or put) your edited file into the instrument by clicking on *Put Setup*. Programmable items will only be displayed if you have told the software that you have the appropriate hardware, such as the dual relay option. Pressing the *F1* key at any time will bring up detailed help information.

An optional analog output is defined in two steps. The input to the device is first scaled to a digital reading in engineering units, and this reading is then converted to the analog output. The digital reading is also used for setpoint control and can be transmitted as serial data.





4.4 ADVANCED FEATURES OF IS SOFTWARE



- **The Commands pull-down menu** allows you to execute certain functions by using your computer mouse. The *Commands* pull-down menu will be grayed out unless a *Get Setup* has been executed.
- **The Readings pull-down menu** provides three formats to display input data on your PC monitor. In all formats, use the *Pause* and *Continue* buttons to control the timing of data collection, then press *Print* for a hardcopy on your PC printer.

- **List** presents the latest digital readings in a 20-row by 10-column table. Press *Pause* at any time to freeze the display. Press *Print* for a hardcopy.
- **Plot** generates a plot of digital readings vs. time in seconds. It effectively turns the instrument-PC combination into a printing digital oscilloscope.
- **Graph** generates a histogram, where the horizontal axis is the reading and the vertical axis is the number of readings. The display continually resizes itself as the number of readings increases.





5. FRONT PANEL SETUP, SERIAL COMMUNICATIONS



5.1 FRONT PANEL SETUP, DIGITAL PANEL METERS & SCALE METER ONLY

 Press Menu Select Key	 Press Digit Select Key	 Press Value Select Key																																
SEr 1 Press  until <i>Ser 1</i> is displayed. Fixed Parameters: - No parity - 8 data bits - 1 stop bit	<u>000</u> Output filtering	<u>0</u> Send unfiltered signal <u>1</u> Send filtered signal																																
	<u>000</u> Baud rate	<u>0</u> 300 baud <u>1</u> 600 baud <u>2</u> 1200 baud <u>3</u> 2400 baud <u>4</u> 4800 baud <u>5</u> 9600 baud <u>6</u> 19200 baud																																
	<u>000</u> Output update rate	<table style="width: 100%; border-collapse: collapse;"> <tr> <td style="width: 50%;"></td> <td style="text-align: center;"><u>60 Hz</u></td> <td style="text-align: center;"><u>50 Hz</u></td> </tr> <tr> <td><u>0</u></td> <td style="text-align: center;">0.017 sec</td> <td style="text-align: center;">0.020 sec</td> </tr> <tr> <td><u>1</u></td> <td style="text-align: center;">0.28 sec</td> <td style="text-align: center;">0.34 sec</td> </tr> <tr> <td><u>2</u></td> <td style="text-align: center;">0.57 sec</td> <td style="text-align: center;">0.68 sec</td> </tr> <tr> <td><u>3</u></td> <td style="text-align: center;">1.1 sec</td> <td style="text-align: center;">1.4 sec</td> </tr> <tr> <td><u>4</u></td> <td style="text-align: center;">2.3 sec</td> <td style="text-align: center;">2.7 sec</td> </tr> <tr> <td><u>5</u></td> <td style="text-align: center;">4.5 sec</td> <td style="text-align: center;">5.4 sec</td> </tr> <tr> <td><u>6</u></td> <td style="text-align: center;">9.1 sec</td> <td style="text-align: center;">10.9 sec</td> </tr> <tr> <td><u>7</u></td> <td style="text-align: center;">18.1 sec</td> <td style="text-align: center;">21.8 sec</td> </tr> <tr> <td><u>8</u></td> <td style="text-align: center;">36.6 sec</td> <td style="text-align: center;">43.5 sec</td> </tr> <tr> <td><u>9</u></td> <td style="text-align: center;">72.5 sec</td> <td style="text-align: center;">86.7 sec</td> </tr> </table>		<u>60 Hz</u>	<u>50 Hz</u>	<u>0</u>	0.017 sec	0.020 sec	<u>1</u>	0.28 sec	0.34 sec	<u>2</u>	0.57 sec	0.68 sec	<u>3</u>	1.1 sec	1.4 sec	<u>4</u>	2.3 sec	2.7 sec	<u>5</u>	4.5 sec	5.4 sec	<u>6</u>	9.1 sec	10.9 sec	<u>7</u>	18.1 sec	21.8 sec	<u>8</u>	36.6 sec	43.5 sec	<u>9</u>	72.5 sec
	<u>60 Hz</u>	<u>50 Hz</u>																																
<u>0</u>	0.017 sec	0.020 sec																																
<u>1</u>	0.28 sec	0.34 sec																																
<u>2</u>	0.57 sec	0.68 sec																																
<u>3</u>	1.1 sec	1.4 sec																																
<u>4</u>	2.3 sec	2.7 sec																																
<u>5</u>	4.5 sec	5.4 sec																																
<u>6</u>	9.1 sec	10.9 sec																																
<u>7</u>	18.1 sec	21.8 sec																																
<u>8</u>	36.6 sec	43.5 sec																																
<u>9</u>	72.5 sec	86.7 sec																																
SEr 2 Serial Setup 2	<u>0000</u> Line feed	<u>0</u> No <LF> following <CR> <u>1</u> <LF> following <CR>																																
	<u>0000</u> Alarm data with readings	<u>0</u> No alarm data with reading <u>1</u> Alarm data with reading																																
	<u>0000</u> Control of data output	<u>0</u> Continuous data output <u>1</u> Data output on ASCII command only																																
	<u>0000</u> Meter address	Select <u>0</u> thru <u>F</u> for addresses 1 thru 15. Select <u>0.</u> thru <u>F.</u> (with decimal point) for addresses 16 thru 31.																																

MENU  Press Menu Select Key	PEAK  Press Digit Select Key	RESET  Press Value Select Key
SEr 3 Serial Setup 3	00000 RS485 half or full duplex	0 Full duplex 1 Half duplex
	00000 Special start & stop char.	0 Standard continuous mode 1 Special start & stop characters
	00000 RTS mode	0 Normal non-latching RTS 1 Single transmission, latching RTS
	00000 Termination characters	0 Only at end of all items 1 At end of each item
	00000 Data sent, digital panel meter only	0 Reading 1 Peak 2 Valley 3 Reading + Peak 4 Reading + Valley 5 Reading + Peak + Valley
	00000 Data sent, scale meter only	0 Net + Gross 1 Net only 2 Gross only 3 Peak only (Net or Gross) 4 Net + Gross + Peak 5 Valley only
SEr 4 Serial Setup 4	000 Modbus ASCII gap timeout	0 1 sec 1 3 sec 2 5 sec 3 10 sec
	000 Serial protocol	0 Custom ASCII 1 Modbus RTU 2 Modbus ASCII
	000 Parity	0 None 1 Odd 2 Even
Addr Modbus Address	000 000 000 Select digit to flash.	158 Select 0 through 9 for flashing digit. Address range is 1 to 247.

5.2 FRONT PANEL SETUP, COUNTERS & TIMERS ONLY

 Press Menu Select Key	 Press Digit Select Key	 Press Value Select Key																																
<p>Ser 1 Serial Setup 1. Press  until <i>Ser 1</i> is displayed.</p> <p>Fixed Parameters</p> <ul style="list-style-type: none"> - No parity - 8 data bits - 1 stop bit 	<p>000 Output filtering</p>	<p>0 Send unfiltered signal 1 Send filtered signal</p>																																
	<p>000 Baud rate</p>	<p>0 300 baud 1 600 baud 2 1200 baud 3 2400 baud 4 4800 baud 5 9600 baud 6 19200 baud</p>																																
	<p>000 Output update rate</p>	<table border="0"> <tr> <td></td> <td style="text-align: center;"><u>60 Hz</u></td> <td style="text-align: center;"><u>50 Hz</u></td> </tr> <tr> <td>0</td> <td>0.017 sec</td> <td>0.020 sec</td> </tr> <tr> <td>1</td> <td>0.28 sec</td> <td>0.34 sec</td> </tr> <tr> <td>2</td> <td>0.57 sec</td> <td>0.68 sec</td> </tr> <tr> <td>3</td> <td>1.1 sec</td> <td>1.4 sec</td> </tr> <tr> <td>4</td> <td>2.3 sec</td> <td>2.7 sec</td> </tr> <tr> <td>5</td> <td>4.5 sec</td> <td>5.4 sec</td> </tr> <tr> <td>6</td> <td>9.1 sec</td> <td>10.9 sec</td> </tr> <tr> <td>7</td> <td>18.1 sec</td> <td>21.8 sec</td> </tr> <tr> <td>8</td> <td>36.6 sec</td> <td>43.5 sec</td> </tr> <tr> <td>9</td> <td>72.5 sec</td> <td>97 sec</td> </tr> </table>		<u>60 Hz</u>	<u>50 Hz</u>	0	0.017 sec	0.020 sec	1	0.28 sec	0.34 sec	2	0.57 sec	0.68 sec	3	1.1 sec	1.4 sec	4	2.3 sec	2.7 sec	5	4.5 sec	5.4 sec	6	9.1 sec	10.9 sec	7	18.1 sec	21.8 sec	8	36.6 sec	43.5 sec	9	72.5 sec
	<u>60 Hz</u>	<u>50 Hz</u>																																
0	0.017 sec	0.020 sec																																
1	0.28 sec	0.34 sec																																
2	0.57 sec	0.68 sec																																
3	1.1 sec	1.4 sec																																
4	2.3 sec	2.7 sec																																
5	4.5 sec	5.4 sec																																
6	9.1 sec	10.9 sec																																
7	18.1 sec	21.8 sec																																
8	36.6 sec	43.5 sec																																
9	72.5 sec	97 sec																																
<p>Ser 2 Serial Setup 2</p>	<p>0000 Line feed</p>	<p>0 No <LF> after <CR> 1 <LF> after <CR></p>																																
	<p>0000 Alarm data with readings</p>	<p>0 No alarm data 1 Alarm data with reading</p>																																
	<p>0000 Control of data output</p>	<p>0 Continuous data output 1 Data output on ASCII command only</p>																																
	<p>0000 Meter address with Custom ASCII protocol</p>	<p>Select 0 thru F for addresses 1 thru 15. Select 0. thru F. (with decimal point) for addresses 16 thru 31.</p>																																
<p>Ser 3 Serial Setup 3</p>	<p>00000 RS485 half or full duplex</p>	<p>0 Full duplex 1 Half duplex</p>																																
	<p>00000 Special start & stop char.</p>	<p>0 Standard continuous mode 1 Special start & stop characters</p>																																

 Press Menu Select Key	 Press Digit Select Key	 Press Value Select Key
Ser 3 (continued)	<u>00000</u> RTS mode	<u>0</u> Normal non-latching RTS <u>1</u> Single transmission, latching RTS
	<u>00000</u> Termination characters	<u>0</u> Only at end of all items <u>1</u> At end of each item
	<u>00000</u> Data sent in continuous mode	<u>0</u> All active items <u>1</u> Item #1 only <u>2</u> Item #2 only (if active) <u>3</u> Item #3 only (if active) <u>4</u> Peak only <u>5</u> Displayed item <u>6</u> Valley only <u>7</u> All active items + Peak
Ser 4 Serial Setup 4	<u>000</u> Modbus* ASCII gap timeout	<u>0</u> 1 sec <u>1</u> 3 sec <u>2</u> 5 sec <u>3</u> 10 sec
	<u>000</u> Serial protocol	<u>0</u> Custom ASCII <u>1</u> Modbus RTU <u>2</u> Modbus ASCII
	<u>000</u> Parity	<u>0</u> None <u>1</u> Odd <u>2</u> Even
Addr Modbus Address	<u>000</u> <u>000</u> <u>000</u> Select digit to flash.	<u>158</u> Select <u>0</u> thru <u>9</u> for flashing digit. Address range is 1 to 247.

6. RS232 & RS485 COMMUNICATION PROTOCOLS

6.1 SERIAL COMMUNICATION FORMAT

The serial communication format for both RS232 and RS485 is the following:

Mode Full Duplex (Separate transmit and receive lines) and Half Duplex (RS485 only)
Baud Rate 300, 600, 1200, 2400, 4800, 9600, 19200 selectable by front panel Menu item
"Ser 1", Sub-menu item "Digit 4" for DPM, "Digit 5" for counter.
Parity None
Word length 8 data bits
Stop bit 1

6.2 MEASUREMENT DATA FORMAT

The basic measurement data format consists of 8 ASCII characters for the DPM, such as +999.99<CR> and 9 characters for the counter, such as +9999.99<CR>, where <CR> is the carriage return character. The first character is always a plus or minus sign. A decimal point is always furnished, even when it follows the last digit.

Adding a Line Feed Character to the Basic Format

Printers and other devices that receive the measurement data may require a line feed character <LF> following the <CR>. The line feed character <LF> may be selected in "Ser 2".

Adding a Coded Data Character to the Basic Format

It is possible to add a coded character from A to H to the data string according to the following table to indicate the alarm and overload status of the device. If used, this character precedes the <CR>, so it is the last printable character in the string. With the optional <LF> and coded character selected, the data string will consist of 10 characters for the DPM +999.99A <CR><LF> and 11 characters for the counter +9999.99A<CR><LF>.

Alarm Status	No Overload	Overload
Neither Alarm set	A	E
Alarm 1 set only	B	F
Alarm 2 set only	C	G
Both Alarms set	D	H

For example, a coded character "G" indicates that Alarm 2 only is set, that the DPM is in the overload condition, and that zero blanking has been selected. This information is useful when data is supplied to a computer for listing and analysis, or when data is supplied to a Remote Display in a Master-Slave configuration.

The Counter and Scale Meter are capable of supplying more than 1 measurement value (or "Item") with each reading, as selected in "Ser 3". In the counter, there can be up to 3 Items plus a Peak value, depending on the selected Function. The scale meter can transmit Net, Gross and Peak weight.

Values are transmitted in a continuous string with no space between them. If the 5th digit in "Ser 3" is set to 1, the termination characters of <CR> and optional <LF> appear after each value. If the 5th digit is set to 0, the termination characters appear only once at the end of the string. In either case, if included, the coded character appears at the end of the last value only.

6.3 NETWORK CONFIGURATIONS

The instruments can operate in a point-to-point mode using RS-232 or RS-485, or in a multi-point mode using RS-485.

The point-to-point mode is a direct connection between a computer (or other digital device) and the instrument.

The multi-point mode is a connection from a host computer to a multiplicity of instruments bused together with their inputs and outputs connected in parallel. For long cable runs, the last device should have a termination resistor installed. It is necessary to set up each device on the bus with a different address from 1 to 31. To command a particular device, its address is used in conjunction with the command, and only that device responds. The outputs of all of the devices on the bus are set to a high impedance state, except the device being addressed. The device addresses range from 1 to 31, with 0 being a special address to which a meter responds only internally (e.g. Reset), but does not transmit any response on the output lines. All devices may be commanded simultaneously with a 0 address, and there will not be any output response contention. Addressing of meters can be set in "Ser 2".

A device operating in a point-to-point mode must also be addressed. Although any address will suffice, it is suggested address = 1 be selected as a standard for the point-to-point mode.

6.4 OPERATING MODES

The instruments can operate in a Continuous Mode or Command Mode.

In the Continuous Mode, measurements are continuously transmitted by the meter in a standard data format. Please see the next manual section.

In the Command Mode, the meter does not send any data automatically, but responds to commands received from a host computer. Please see the manual section following the Continuous Mode.

7. CONTINUOUS MODE

7.1 OVERVIEW

In the Continuous Operating Mode, measurements are continuously transmitted by the instrument in a standard data format using printable ASCII characters at a user-selectable rate ranging from 50 or 60 Hz line frequency down to one measurement every 72 seconds. This data may be received by a remote display at a distant location, by a printer for data logging purposes, or by a host computer for data analysis or system control.

Both hardware (RTS) and software (XON/XOFF) handshaking are available for RS232, but neither is available for RS485.

7.1 INSTRUMENTS WITH DPM OR SCALE METER MAIN BOARD

The transmission rate of the measurement data can be selected in "Ser 1". The meter conversion rate equals the AC power frequency (50 or 60 Hz). Any baud rate may be used, but if less than the minimum baud rate in the table, the transmission rate will decrease accordingly.

Output Rate	Data Output Rate	Minimum Baud Rate		
"Ser 1" Setting	50 Hz / 60 Hz	1 Item Sent	2 Items Sent	3 Items Sent
0	0.21s / .018 s	9600	9600	19200
1	.34 s / 0.28 s	600	600 / 1200	1200
2	.68 s / 0.57 s	300	300 / 600	600
3	1.4 s / 1.1 s	300	300	300
4	2.7 s / 2.3 s	300	300	300
5	5.4 s / 4.5 s	300	300	300
6	1.9 s / 9.1 s	300	300	300
7	21.8 s / 18.1 s	300	300	300
8	43.5 s / 36.3 s	300	300	300
9	86.7s / 72.3 s	300	300	300

7.2 INSTRUMENTS WITH COUNTER / TIMER MAIN BOARD

The transmission rate of the measurement data can be selected in "Ser 1". Data transmission is initiated at the end of the calculation time following the gate time. Data is completely transmitted for one measurement before the calculation of the next measurement is started. Therefore, the reading rate is influenced by the baud rate, the number of items transmitted, and gate time. If the selected gate time is less than that shown in the table below, it is not the determining factor of the reading rate. If it is greater, then it is the determining factor. Time intervals (reciprocal of rate) between transmissions at the reading rate are:

Baud Rate	Time 1 Item	Min Gate	Time 2 Items	Min Gate	Time 3 Items	Min Gate	Time 4 Items	Min Gate
300	.37s	.34s	.70s	.67s	1.03s	1.00s	1.37s	1.34s
600	.18s	.15s	.35s	.32s	.52s	.49s	.68s	.65s
1200	.09s	.06s	.18s	.15s	.26s	.23s	.34s	.31s
2400	.05s	.02s	.09s	.06s	.13s	.10s	.17s	.14s
4800	.02s	.01s	.04s	.01s	.07s	.04s	.09s	.06s
9600	.01s	.01s	.02s	.01s	.03s	.01s	.04s	.01s
19200	.01s	.01s	.01s	.01s	.02	.01s	.01s	.01s

The data transmission rate may be reduced by sending data every other reading, every fourth reading, or less. This selection is made in "Ser 1". A computer, if busy with other tasks, may be unable to keep up with the faster data rates of the meter, so a handshake function is available that provides the computer with control over the meters' data transmissions.

7.3 RTS CONTROL

RTS control does not apply to RS485. DPMs and counter / timers have two RS232 RTS modes: unlatched and latched.

In the unlatched mode, the measurement transmission is enabled by a high RTS level and is disabled by a low RTS level. When disabled, any character being sent is completed. When enabled, any characters remaining in the data format are transmitted before the next measurement transmission. The computer, when its receive buffer is nearly full, takes the RTS line low to halt data transmission. When its receive buffer has emptied, it takes the RTS line high to enable more data transmissions. Some measurements could be missed in the process. The latched and unlatched modes are selected in "config" "digit 2" in the DPM and by "Ser 3" in the Counter and Scale Meter.

In the latched mode, the RTS input is polled every 3.3 ms. When a high level is detected, RTS is latched true, even though the RTS line goes low immediately. At the end of each calculation, the latched RTS value is checked. If it is true, a complete measurement transmission (from 1 to 4 values) is made without interruption, regardless of the state of the RTS line during that time. At the end of the complete transmission, the latched RTS value is reset false, even though the RTS line may be high at that instant. The RTS latch does not go true again until the RTS line is first returned to a low level after the completion of the transmission and then is taken high again. Latched control provides "print command" operation by sending a transmission for each RTS pulse. If a second pulse occurs during the transmission, it is not recognized.

7.3 XON / XOFF CONTROL

Applicable to RS232, not RS485. A measurement transmission is enabled by the receipt of an ASCII XON character. It is disabled by the receipt of an ASCII XOFF character.

8. COMMAND MODE

8.1 OVERVIEW

In the Command Mode, the device does not send any data automatically, but responds to commands received from a host computer. These commands can be:

- To transmit the latest or peak measurement
- To reset the meter completely or just the peak value and/or latched alarms
- To display a value sent from the computer
- To transmit present setup parameters
- To receive new setup parameters,
- To monitor or alter data in selected memory locations of the meter.

The selection of either the Continuous mode or the Command Mode can be made from the front panel Menu selection “Ser 2”. The meter will not respond to a command in the Continuous Mode, except the command “A1”, which puts the meter into the Command Mode.

8.2 COMMAND MODE FORMAT

The minimum format is 4 characters. Example: *5A1

After any command that causes a Meter Reset, such as C0, F, W, X, the Counter sends an “R” character after the Reset is complete and the Counter is ready to accept a new command.

CHAR 1 - COMMAND IDENTIFIER

All commands begin with “*” followed by the meter address, then a command letter followed by a sub-command number or letter. Additional characters may be appended. All commands terminate with <CR> (<LF> ignored). The counter may be assigned a different recognition character via the RS232 / 485 serial port, but will still recognize the “*”.

Char #	Character	Description
1	*	Command Identifier (Recognition Character)
2	0-V	Device Address (0 addresses all devices, 1-V specific)
3	A-Z	Command Function
4	0-U	Sub-command (or # Bytes or Words of data being transferred)

CHAR 2 - ADDRESS CODES

The next table is the Serial Communication Address Codes following the “*” for each meter address number. Also shown is the corresponding character that is set in menu item “SER 2”.

Meter #	Meter SER 2 Digit 5(6)	Serial Comm Address Code
1	1	1
2	2	2
3	3	3
4	4	4
5	5	5
6	6	6
7	7	7
8	8	8
9	9	9
10	A	A
11	B	B
12	C	C
13	D	D
14	E	E
15	F	F

Meter #	Meter SER 2 Digit 5(6)	Serial Comm Address Code
16	0.	G
17	1.	H
18	2.	I
19	3.	J
20	4.	K
21	5.	L
22	6.	M
23	7.	N
24	8.	O
25	9.	P
26	A.	Q
27	B.	R
28	C.	S
29	D.	T
30	E.	U
31	F.	V

CHARS 3 & 4 - COMMANDS AND SUBCOMMANDS

The examples below use a default address of 1 following the “*”. Substitute the desired address from the above table of Serial Comm Address Codes. All command sequences shown must terminate with <CR>, followed by an optional <LF>.

COMMUNICATIONS MODE

Continuous mode *1A0
 Command mode *1A1

REQUEST DPM VALUES

Get reading** *1B1
 Peak reading *1B2
 Valley reading *1B3

** The meter transmits the value or values selected in Ser 3.

REQUEST SCALE METER VALUES

Get reading** *1B1
 Peak only *1B2
 Net only *1B3
 Gross only *1B4
 Valley only *1B5

** The meter transmits the value or values selected in Ser 3.

REQUEST COUNTER VALUES

All active items	*1B0
Item 1	*1B1
Item 2	*1B2
Item 3	*1B3
Peak	*1B4
Displayed item	*1B5
Valley only	*1B6
All active items + Peak + Valley	*1B7

RESET FUNCTIONS, DPM & SCALE METER

Cold reset	*1C0	Reads NVMEM into RAM locations after RAM is zeroed.
Latched alarms reset	*1C2	
Peak value reset	*1C3	
Remote display reset	*1C4	
External Input B true	*1C5	
External Input B false	*1C6	
External Input A true	*1C7	
External Input A false	*1C8	
Valley reset	*1C9	
Tare function	*1CA	
Tare reset	*1CB	

RESET FUNCTIONS, COUNTER / TIMER

Cold reset	*1C0	Reads NVMEM into RAM locations after RAM zeroed.
Function reset	*1C1	Resets all total values and/or peak value.
Latched alarms reset	*1C2	
Peak value reset	*1C3	
Remote display reset	*1C4	Resets Item 3 to zero if not Arith or Batch. Removes Alarm View or Peak View if on.
External Input B true	*1C5	
External Input B false	*1C6	
External Input A true	*1C7	
External Input A false	*1C8	
Valley value reset	*1CA	

8.3 READING AND WRITING TO RAM AND NONVOLATILE MEMORY

CHARACTERS 1, 2

The Recognition character and Meter Address Code are the same as shown in previous table.

CHARACTER 3

Command character:

- G Read bytes from RAM Memory
- F Write bytes to RAM Memory (DPM and Scale meter only)
- R Read bytes from Upper RAM Memory
- Q Write bytes to Upper RAM Memory
- X Read words from Non-Volatile Memory
- W Write words to Non-Volatile Memory

CHARACTER 4

Command character

Code #	Code #	Code #	Code #
1 = 1	9 = 9	H = 17	P = 25
2 = 2	A = 10	I = 18	Q = 26
3 = 3	B = 11	J = 19	R = 27
4 = 4	C = 12	K = 20	S = 28
5 = 5	D = 13	L = 21	T = 29
6 = 6	E = 14	M = 22	U = 30
7 = 7	F = 15	N = 23	
8 = 8	G = 16	O = 24	

CHARACTERS 5, 6

See tables for the RAM MEMORY ADDRESSES and NONVOLATILE MEMORY ADDRESSES with their respective data definitions.

GENERAL, READING AND WRITING RAM MEMORY DATA

RAM memory data is read and written as a continuous string of bytes consisting of 2 hex characters (0-9,A-F) per byte. Included in the command are the total number of bytes to be transferred and the most significant address in RAM of the continuous string of bytes. The format is:

- Read lower RAM data *1Gnaa
- Write lower RAM data *1Fnaa<data>
- Read upper RAM data *1Rnaa
- Write upper RAM data *1Qnaa<data>

where: n is the number of bytes to be read or written.
aa is the most significant address in RAM of the bytes to be read or written.
<data> is n bytes of 2 hex characters per byte in order from the most to the least significant byte.

The number of bytes n consists of a single code character representing values from 1 to 30 as shown above under CHARACTER 4. The most significant address aa consists of 2 hex characters as shown below under RAM MEMORY ADDRESSES AND DATA DEFINITIONS.

GENERAL, READING AND WRITING NONVOLATILE MEMORY DATA

Nonvolatile data is read and written as a continuous string of words consisting of 2 bytes or 4 hex characters (0-9,A-F) per word. Included in the command is the total number of words to be transferred and the most significant address in nonvolatile memory of the continuous string of words. The format is:

Read nonvolatile memory data *1Xnaa (followed by Meter reset)
Write non-volatile memory data *1Wnaa <data> (followed by Meter reset)

where: n is the number of words to be read or written.

 aa is the most significant address in nonvolatile memory of the words to be read or written.

 <data> is n words of 2 bytes or 4 hex characters per word in order from the most to the least significant address

The coded number of words n consists of a single character representing values from 1 to 30 as shown under CHARACTER 4. The most significant address aa consists of 2 hex characters as shown under NONVOLATILE MEMORY ADDRESSES.

8.4 COMMAND MODE FOR REMOTE DISPLAY OPERATION OF DPM

OVERVIEW

A DPM can serve as a remote display that responds to values sent via serial communications by a PC or by another DPM in a Master-Slave configuration. In one application, the DPM sends readings to a PC, which then processes the readings and transmits values back to the DPM for display. There are 3 modes in which the DPM may act as a remote display:

MODE 1: DPM with Signal Conditioner Card and not in Remote Display Mode

SETUP (left digit)	= 0	4-1/2 digit DPM
	= 2	4-1/2 digit DPM with Count by 10
	= 3	3-1/2 digit DPM

The baud rate must be set the same as the source. The PC Controller uses the H command to cause the display to halt its normal readings and display the value sent by Serial Communications instead. The DPM must be in the Command mode to receive the data. The data format sent via Serial Communications is:

*#HSDDDDD.A <CR> where the decimal point is in front, behind (as shown), or between the D's (digits).

A total of 11 characters plus a CR must be included and sent as ASCII characters. Those in quotes below are included as shown. The other symbols represent a range of characters except for CR which is the ASCII character "0D".

* = Command identifier

- # = Device address from 1 to 9, A to V, or 0 for common address
- H = Command letter
- S = Sign of value, space (or +) for positive, - for negative value
- D = Digit from 0 to 9
- * = Decimal point placement and must always be included
- A = Alarm and overload character code, A to H
- <CR> = Carriage return character

The following table lists the Alarm and Overload characters.

ALARM CONDITION	NO OVERLOAD	OVERLOAD
Neither Alarm on	A	E
Alarm 1 only on	B	F
Alarm 2 only on	C	G
Alarms 1 & 2 on	D	H

If the DPM is in the Continuous mode, it must be put into the Command mode by sending `*#A1` prior to sending the remote display value.

The Remote Display value remains on the display until one of the following occurrences:

- a. The command `*#C4` is sent removing the Remote Display value and returning to the normal readings without resetting the DPM.
- b. The command `*#C0` is sent causing a Cold Reset of the DPM.
- c. The command `*#C1` is sent causing a Warm Reset of the DPM.
- d. Front panel pushbuttons RESET and MENU are simultaneously pushed to cause a Cold Reset of the DPM.

Notes: After the Remote Display value is entered, the DPM can be put back in the Continuous mode with the command `*#A0` without disturbing the display's value. DPM must be in the Command mode for a., b., or c. above. It may be put into the Command mode while displaying a remote display value with the `*1A1` command without affecting the display.

If PEAK (manual or external) or ALARM VIEW (manual) is activated while the remote value is being displayed, the peak or alarm value is displayed and cannot be removed except by Remote Display Reset (a., b., or c. above in Command mode) or by manual RESET. If a Remote Display value is sent while in PEAK or ALARM VIEW, it is ignored, but when PEAK or ALARM VIEW is turned off, the Remote Display value comes on.

MODE 2: DPM with Signal Conditioner Card and in Remote Display Mode

SETUP (left digit) = 1 Remote Display mode

The baud rate must be set the same as the source which may be a PC Controller or another DPM. The format is the Slave Format. This is the same as MODE 1 above but without the

Command Identifier “*”, the address #, and the Command letter “H”. This is the same format that data is transmitted from a DPM in the Continuous mode. The string of characters must be exactly 8 characters plus the CR in length.

SDDDDD.A <CR>

No commands can be received in this mode but the front panel MENU can be accessed. Any transmissions received other than properly formatted data will result in a meaningless display. Alarm setpoints, Peak readings and external control functions are disabled while the Remote Display value is being displayed. When the DPM is Reset, it displays RESET continuously until data is received.

DATA FORMAT

*1HSDDDDD.A

S = Sign, either blank (for +) or -

D = Digit from 0 to 9, five digits total. Always include a decimal point even at the end.

A = Alarm character as defined in ???.

8.5 COMMAND MODE FOR REMOTE DISPLAY OPERATION OF COUNTER / TIMER

The Counter has 13 Display Modes (0-12). Modes 0-5 are normal measurement modes. Modes 6-12 are dedicated to Remote Display without making any normal readings. In any of the 13 modes, remote display data may be received via RS-232 or RS-485 and be displayed. The remote data requirements and the Remote Display capabilities vary for the different display modes and selected Input Functions. The mode is selected by Menu item “ConFIG” “Digit 3” from the following list:

Normal Readings While Displaying Remote Data		Addressable Commands
0	Normal display, Exponent Overflow	H, K or L
1	Normal display, 999999 Overflow	H, K or L
2	1 right-hand dummy zero	H, K or L
3	2 right-hand dummy zeros	H, K or L
4	Real time clock, multi-format	H, K or L
5	Real time clock, hh.mm,ss	H, K or L

Remote Display Only – No Normal Readings		Addressable Commands
6	Addressable remote display	H, K or L commands
7	Single value remote display	1 value only
8	1st value of value sequence	1-4 sequential Values
9	2nd value of value sequence	2-4 sequential Values
A	3rd value of value sequence	3-4 sequential Values

B	4th value of value sequence	4 sequential Values
C	Programmed to select specific data from a data string	1 value only

The addressable commands of Modes 0-6 can display remote data on one or more Counters having the command address in a multi-point configuration or a single Counter having the command address in a Point-to-point configuration. Modes 7 - 11 (B) do not use addressable commands, but values only. They are primarily designed for Host Counter or Scale meter to Slave Counter or remote display applications but may be used also in Host Computer to Remote Display Counter configurations. Since the Host Counter may be selected to transmit up to four sequential measurement values, Item 1, Item 2, Item 3 and Peak, (Scale meter transmits up to 3 values) each measurement cycle, Modes 8-11 provide the ability of the Remote Display to extract one of four sequential values and display it.

Modes 0-5 are normal counter modes that may be commanded as follows:

1. **H Command.** Overrides the normal display reading only.
2. **K Command.** The value is not displayed, but is stored as Item 3 if Item 3 is not being used. It may then become the source, if selected, for the Alarm comparison and the Analog Output. Item 3 is normally only used for the Batch and Arithmetic functions.
3. **L Command.** Both 1 and 2.

In addition, the H, K, L commands may or may not include a coded Alarm character. If included, this character always overrides the internal Alarm comparisons and determines the alarm indicators, the relay operation and the alarm character sent with the serial communications. Readings continue to be made internally during Remote Display operation and may be received by a Host Computer, manipulated, and returned as remote data. When reset by a *1C4 Command, the display returns to its internal readings, the Alarms to its internal comparisons, the Analog Output to zero and the Item 3 value to zero. A signal conditioner board must be present in these modes to return to normal readings. If no signal conditioner board is present, any Mode setting from 0-5 automatically changes to Mode 6.

Modes 6-11 are used for remote display operation only. No normal readings are made. A signal conditioner board is optional, and if present, is ignored. When reset, the display shows "rESet" until the first remote display data is received.

Mode 6 is an addressable remote display mode that uses the H, K, L commands.

Mode 7 is not addressable, and data representing a value to be displayed is received in a point-to-point connection. In addition to being displayed, that value is put into Item 3, where it may be selected for Alarm comparisons and/or for Analog Output. If a Coded Alarm character is included, it overrides the internal alarm comparisons.

Modes 8-11 are able to extract one value of data from a sequence of values, and display that particular value only. Using this mode, multiple slave counters connected to a Host Counter

could each be displaying a different Item value. Also, the extracted value is put into Item 3 where it may be selected for Alarm comparisons and/or Analog Output. If a Coded Alarm character is included at the end of the sequence, it is ignored. The remote display reading can only be changed by Meter Reset, a *1C4 Remote display reset command, or another remote display H or L command.

Mode 12 - Remote display "C" allows extraction of data from an ASCII string that contains multiple data values or non-numeric characters. It can accommodate selected Start and Stop characters. Any number of characters between the Start character and the data can be masked OFF. Up to 8 display characters (including sign and DP) can be masked ON. Any number of characters between the last displayed character and the Stop character can be masked OFF.

When CONFIG, CXXX is set, the meter is a Masked Remote Display, and the following parameters determine its operation. These must be set while the meter is set to something other than CONFIG, CXXX, because that is the one setting for which there is no serial communication with the meter. It is suggested to use CONFIG, 6XXX to set the following parameters, and then to use CONFIG, CXXX for operation.

1. START character (set to 00 if none desired).
2. STOP character (set to 00 if none desired).
Note: Only one of the above can be set to 00.
3. Number of characters following the START character to be ignored.
4. Number of characters following the ignored characters to be displayed.

Either Instrument Setup.exe or Serial.exe may be used to set the values for the Remote Display C mode. These programs may be downloaded from our website.

DATA FORMATS

The basic two Command formats of the data sent via Serial Communications are:

*#CSDDDDDD.A<CR><LF> where the decimal point is to the right of any one of the D's (digits).

*#CSD.DDDEPA<CR><LF> This is the exponential format. The decimal point is fixed.

Alarm comparison and Analog Output are not valid in this format.

- * = Recognition character
- # = Device address from 1-9, A to V, or 0 for common address.
- C = Command letter H, K, L.
- S = Sign of value, space (or +) for positive, - for negative value. Sign is optional in display modes 0-7, required in 8-11.
- D = Digit from 0 to 9. Number of digits may be 1-6 in display modes 0-7, but must be 6 in 8-11.
- P = Power of 10. 0-9, A-F where A-F represents 10-15
- A = Optional Alarm Character as defined in section 2.1
- <CR> = Carriage return character
- <LF> = Optional line feed character (ignored)

These basic Command formats are used when the Remote Display Counter is in display modes 0 - 6. The basic Data formats are the same except *#C is omitted. The basic Data formats are used in display mode 7.

Single or multiple (2-4) Data formats are used in display modes 8-11. Example:

SDDDDDD.SDDDDDD.SDDDDDD.SDDDDDD.A<CR><LF>
 <LF> optional, "Ser 3" "Digit 5" = 0, termination characters only at end of data string or
 SDDDDDD.<CR><LF>SDDDDDD.<CR><LF>SDDDDDD.<CR><LF>SDDDDDD.A<CR><LF>
 "Ser 3" "Digit 5" = 1, termination characters at end of each data item.

8.6 RECOGNITION CHARACTER, AND START AND STOP CHARACTERS

The meter recognizes an asterisk (*) as the command recognition character. In the counter, another command recognition character may be chosen to make the meter compatible with an existing system. The meter will still respond to an asterisk. For all meters, in continuous mode, a device ,such as a printer, may require a start and stop bit to recognize the data string being sent. Normally there is no start bit and the stop bit is a carriage return <CR>. When the Counter is in a normal operating mode (not Remote Display), SER 3, XDXXX can be set for the following combinations:

D	Command Recognition Character	Continuous Readings	
		Start Character	Stop Character
0	*	None	CR
1	Selected	None	CR
2	*	Selected	Selected
3	Selected	Selected	Selected

Either Instrument Setup.exe or Serial.exe may be used to set the Command recognition character and the start stop characters. These programs may be downloaded from our website.

9. APPENDIX A: DPM MEMORY ADDRESSES AND DATA DEFINITIONS

9.1 DPM 1-BYTE RAM MEMORY DATA

(L) = Lower memory, (U) = Upper memory

Hex Address	Item Name	Bit Assignment																																																																																																																																																									
DE (L)	Configuration	<table style="width: 100%; border-collapse: collapse;"> <tr> <td style="width: 10%;">Bit 7</td> <td style="width: 10%;">6</td> <td style="width: 10%;">5</td> <td style="width: 10%;">4</td> <td style="width: 10%;">3</td> <td style="width: 10%;">2</td> <td style="width: 10%;">1</td> <td style="width: 10%;">0</td> <td></td> </tr> <tr> <td></td> <td></td> <td></td> <td></td> <td></td> <td></td> <td></td> <td>0</td> <td>Linear data</td> </tr> <tr> <td></td> <td></td> <td></td> <td></td> <td></td> <td></td> <td></td> <td>1</td> <td>Custom curve (Extended DPM)</td> </tr> <tr> <td></td> <td></td> <td></td> <td></td> <td></td> <td></td> <td></td> <td>0</td> <td>Spare</td> </tr> <tr> <td></td> <td></td> <td></td> <td></td> <td></td> <td></td> <td></td> <td>0</td> <td>No Auto-Tare</td> </tr> <tr> <td></td> <td></td> <td></td> <td></td> <td></td> <td></td> <td></td> <td>1</td> <td>Auto-Tare</td> </tr> <tr> <td></td> <td></td> <td></td> <td>0</td> <td>0</td> <td></td> <td></td> <td></td> <td>Peak button displays Peak</td> </tr> <tr> <td></td> <td></td> <td></td> <td>0</td> <td>1</td> <td></td> <td></td> <td></td> <td>Peak button displays Valley</td> </tr> <tr> <td></td> <td></td> <td></td> <td>1</td> <td>0</td> <td></td> <td></td> <td></td> <td>Peak b. displays Peak then Valley</td> </tr> <tr> <td></td> <td></td> <td></td> <td>1</td> <td>1</td> <td></td> <td></td> <td></td> <td>Peak button tares the meter</td> </tr> <tr> <td></td> <td></td> <td>0</td> <td>0</td> <td>0</td> <td></td> <td></td> <td></td> <td>Not rate</td> </tr> <tr> <td></td> <td></td> <td>0</td> <td>0</td> <td>1</td> <td></td> <td></td> <td></td> <td>Rate x 0.1</td> </tr> <tr> <td></td> <td></td> <td>0</td> <td>1</td> <td>0</td> <td></td> <td></td> <td></td> <td>Rate x 1</td> </tr> <tr> <td></td> <td></td> <td>0</td> <td>1</td> <td>1</td> <td></td> <td></td> <td></td> <td>Rate x 10</td> </tr> <tr> <td></td> <td></td> <td>1</td> <td>0</td> <td>0</td> <td></td> <td></td> <td></td> <td>Rate x 100</td> </tr> <tr> <td></td> <td></td> <td>1</td> <td>0</td> <td>1</td> <td></td> <td></td> <td></td> <td>Rate x 1000</td> </tr> <tr> <td></td> <td></td> <td>1</td> <td>1</td> <td>0</td> <td></td> <td></td> <td></td> <td>Rate x 10,000</td> </tr> </table>	Bit 7	6	5	4	3	2	1	0									0	Linear data								1	Custom curve (Extended DPM)								0	Spare								0	No Auto-Tare								1	Auto-Tare				0	0				Peak button displays Peak				0	1				Peak button displays Valley				1	0				Peak b. displays Peak then Valley				1	1				Peak button tares the meter			0	0	0				Not rate			0	0	1				Rate x 0.1			0	1	0				Rate x 1			0	1	1				Rate x 10			1	0	0				Rate x 100			1	0	1				Rate x 1000			1	1	0				Rate x 10,000
Bit 7	6	5	4	3	2	1	0																																																																																																																																																				
							0	Linear data																																																																																																																																																			
							1	Custom curve (Extended DPM)																																																																																																																																																			
							0	Spare																																																																																																																																																			
							0	No Auto-Tare																																																																																																																																																			
							1	Auto-Tare																																																																																																																																																			
			0	0				Peak button displays Peak																																																																																																																																																			
			0	1				Peak button displays Valley																																																																																																																																																			
			1	0				Peak b. displays Peak then Valley																																																																																																																																																			
			1	1				Peak button tares the meter																																																																																																																																																			
		0	0	0				Not rate																																																																																																																																																			
		0	0	1				Rate x 0.1																																																																																																																																																			
		0	1	0				Rate x 1																																																																																																																																																			
		0	1	1				Rate x 10																																																																																																																																																			
		1	0	0				Rate x 100																																																																																																																																																			
		1	0	1				Rate x 1000																																																																																																																																																			
		1	1	0				Rate x 10,000																																																																																																																																																			
BF (L)	Analog Setup	<table style="width: 100%; border-collapse: collapse;"> <tr> <td style="width: 10%;">Bit 7</td> <td style="width: 10%;">6</td> <td style="width: 10%;">5</td> <td style="width: 10%;">4</td> <td style="width: 10%;">3</td> <td style="width: 10%;">2</td> <td style="width: 10%;">1</td> <td style="width: 10%;">0</td> <td></td> </tr> <tr> <td></td> <td></td> <td></td> <td></td> <td></td> <td></td> <td></td> <td>0</td> <td>Analog output unfiltered</td> </tr> <tr> <td></td> <td></td> <td></td> <td></td> <td></td> <td></td> <td></td> <td>1</td> <td>Analog output filtered</td> </tr> <tr> <td></td> <td></td> <td></td> <td></td> <td></td> <td>0</td> <td>0</td> <td></td> <td>0-20 mA current output</td> </tr> <tr> <td></td> <td></td> <td></td> <td></td> <td></td> <td>0</td> <td>1</td> <td></td> <td>0-10V voltage output</td> </tr> <tr> <td></td> <td></td> <td></td> <td></td> <td></td> <td>1</td> <td>0</td> <td></td> <td>4-20 mA current output</td> </tr> </table>	Bit 7	6	5	4	3	2	1	0									0	Analog output unfiltered								1	Analog output filtered						0	0		0-20 mA current output						0	1		0-10V voltage output						1	0		4-20 mA current output																																																																																																			
Bit 7	6	5	4	3	2	1	0																																																																																																																																																				
							0	Analog output unfiltered																																																																																																																																																			
							1	Analog output filtered																																																																																																																																																			
					0	0		0-20 mA current output																																																																																																																																																			
					0	1		0-10V voltage output																																																																																																																																																			
					1	0		4-20 mA current output																																																																																																																																																			
69 (L)	Serial Cnfg3	<table style="width: 100%; border-collapse: collapse;"> <tr> <td style="width: 10%;">Bit 7</td> <td style="width: 10%;">6</td> <td style="width: 10%;">5</td> <td style="width: 10%;">4</td> <td style="width: 10%;">3</td> <td style="width: 10%;">2</td> <td style="width: 10%;">1</td> <td style="width: 10%;">0</td> <td></td> </tr> <tr> <td></td> <td></td> <td></td> <td></td> <td></td> <td>0</td> <td>0</td> <td>0</td> <td>Send Reading</td> </tr> <tr> <td></td> <td></td> <td></td> <td></td> <td></td> <td>0</td> <td>0</td> <td>1</td> <td>Send Peak</td> </tr> <tr> <td></td> <td></td> <td></td> <td></td> <td></td> <td>0</td> <td>1</td> <td>0</td> <td>Send Valley</td> </tr> <tr> <td></td> <td></td> <td></td> <td></td> <td></td> <td>0</td> <td>1</td> <td>1</td> <td>Send Reading + Peak</td> </tr> <tr> <td></td> <td></td> <td></td> <td></td> <td></td> <td>1</td> <td>0</td> <td>0</td> <td>Send Reading + Peak + Valley</td> </tr> <tr> <td></td> <td></td> <td></td> <td></td> <td>0</td> <td></td> <td></td> <td></td> <td><CR> or <CR><LF> at end of all Items</td> </tr> <tr> <td></td> <td></td> <td></td> <td></td> <td>1</td> <td></td> <td></td> <td></td> <td><CR> or <CR><LF> at end of each Item (if no Alarm character)</td> </tr> <tr> <td></td> <td></td> <td></td> <td>0</td> <td></td> <td></td> <td></td> <td></td> <td>Non-latching RTS</td> </tr> <tr> <td></td> <td></td> <td></td> <td>1</td> <td></td> <td></td> <td></td> <td></td> <td>Latching RTS</td> </tr> </table>	Bit 7	6	5	4	3	2	1	0							0	0	0	Send Reading						0	0	1	Send Peak						0	1	0	Send Valley						0	1	1	Send Reading + Peak						1	0	0	Send Reading + Peak + Valley					0				<CR> or <CR><LF> at end of all Items					1				<CR> or <CR><LF> at end of each Item (if no Alarm character)				0					Non-latching RTS				1					Latching RTS																																																															
Bit 7	6	5	4	3	2	1	0																																																																																																																																																				
					0	0	0	Send Reading																																																																																																																																																			
					0	0	1	Send Peak																																																																																																																																																			
					0	1	0	Send Valley																																																																																																																																																			
					0	1	1	Send Reading + Peak																																																																																																																																																			
					1	0	0	Send Reading + Peak + Valley																																																																																																																																																			
				0				<CR> or <CR><LF> at end of all Items																																																																																																																																																			
				1				<CR> or <CR><LF> at end of each Item (if no Alarm character)																																																																																																																																																			
			0					Non-latching RTS																																																																																																																																																			
			1					Latching RTS																																																																																																																																																			

		0 1 0 1	Normal continuous TX Special Start & Stop characters Full duplex Half duplex
35 (L)	Decimal Point	01 02 03 04 05 06	Byte values in hex XXXXX. (2 hex characters/byte) XXXX.X XXX.XX XX.XXX X.XXXX .XXXXX
34 (L)	Lockout2 0 = unlocked 1 = locked	Bit 7 6 5 4 3 2 1 0 1 1 1 1 1 1 1	<u>Menu item & front panel lockout</u> 1 Serial configuration 1 Analog output scaling 1 Alarm setpoint programming 1 Alarm setup 1 Front panel DPM reset 1 Front panel Peak & Alarm reset 1 View alarm setpoints 1 View Peak value & Tare function
33 (L)	Lockout1 0 = unlocked 1 = locked	Bit 7 6 5 4 3 2 1 0 1 1 1 1 1	<u>Menu item & front panel lockout</u> 1 Offset, Lo & Hi readings 1 Scale, Lo In, Hi In 1 Filter Setup 1 Setup, Config & Decimal Point 1 InPut Menu Item
32 (L)	Serial Cnfg2	Bit 7 6 5 4 3 2 1 0 X X X X X 0 1 0 1 0 1	Binary Custom ASCII addr. 0-31 Continuous mode Command mode Alarm data not included with rdg. Alarm data included with rdg. No <LF> following <CR> <LF> following <CR>

31 (L)	Serial Cnfg1	Bit 7	6	5	4	3	2	1	0	<u>Continuous Output Data Rate</u>			
											<u>60 Hz</u>	<u>50 Hz</u>	
						0	0	0	0		0.017s	0.02s	
						0	0	0	1		0.28	0.34	
						0	0	1	0		0.57	0.68	
						0	0	1	1		1.1	1.4	
						0	1	0	0		2.3	2.7	
						0	1	0	1		4.5	5.4	
						0	1	1	0		9.1	10.9	
						0	1	1	1		18.1	21.8	
						1	0	0	0		36.3	43.5	
						1	0	0	1		1:13	1:27	
						1	0	1	0		2:25	2:54	
						1	0	1	1		4:50	5:48	
						1	1	0	0		9:40	11:36	
						1	1	0	1		19:20	23:13	
						1	1	1	0		38:41	46:25	
				1	1	1	1		1:17:21	1:32:51			
			0	0	0					300 baud			
			0	0	1					600 baud			
			0	1	0					1200 baud			
			0	1	1					2400 baud			
			1	0	0					4800 baud			
			1	0	1					9600 baud			
			1	1	0					19200 baud			
		0								Send unfiltered value			
		1								Send filtered value			
2F (L)	Filter	Bit 7	6	5	4	3	2	1	0				
						0	0	0	0		Auto Filter		
						0	0	0	1		Batch (16 samples) filter		
											Time constant	<u>60 Hz</u>	<u>50 Hz</u>
						0	0	1	0		Moving average	0.07 s	0.085 s
						0	0	1	1		Moving average	0.14	0.17
						0	1	0	0		Moving average	0.28	0.34
						0	1	0	1		Moving average	0.57	0.68
						0	1	1	0		Moving average	1.13	1.36
						0	1	1	1		Moving average	2.27	2.72
						1	0	0	0		Moving average	4.53	5.44
						1	0	0	1		Moving average	9.06	10.88
						1	0	1	0		Unfiltered		
		0							Low adaptive threshold				

		1 0 1 0 1 0 1	High adaptive threshold Display batch Display filtered signal Take peak of unfiltered signal Take peak of filtered signal Alarm from unfiltered signal Alarm from filtered signal
35 (U)	Modbus Addr.	00 to FF	Modbus address 0-255 (in Hex format)
09 (U)	Setup	Bit 7 6 5 4 3 2 1 0 * Both ExtinA & * ExtinB = * Function reset *	EXT IN A EXT IN B Reset Meter Hold Reset Peak Display Meter Hold Peak Display Meter Hold Tare Peak Display Tare Tare Reset External Decimal Point 1 External Decimal Point 2 1 Coordinates of 2 points for Scale, Offset 0 Scale and Offset direct parameters 0 Normal Format, Ser Com Continuous mode 1 Special Start & Stop characters 0 60 Hz power 1 50 Hz power 0 0 4-1/2 digit display (0.1° for temp.) 0 1 Remote display 1 0 4-1/2 digits count by 10 (0.01° for RTD) 1 1 3-1/2 digit display (1° for temp.)
0D (U)	Alarm Config4	Bit 7 6 5 4 3 2 1 0 0 0 0 0 0 1 0 1 0 0 1 1 1 0 0 1 0 1 1 1 0 1 1 1 0 0 0 0 0 1	<u>Alarm Trigger Delay</u> <u>60 Hz</u> <u>50Hz</u> 0.018 s 0.021 s 0.035 0.043 0.07 0.085 0.14 0.17 0.28 0.34 0.56 0.68 1.13 1.36 2.27 2.72 AI3 Band Dev, AI4 Band Dev AI3 Hysteresis, AI4 Band Dev

		0 1 0	AI3 Band Dev, AI4 Hysteresis
		0 1 1	AI3 Hysteresis, AI4 Hysteresis
		1 0 0	No deviation in menus or calc
0C (U)	Alarm Config3	Bit 7 6 5 4 3 2 1 0	
		0 0 0 0	AI3 Hi active, AI4 Hi active
		0 0 0 1	AI3 Lo active, AI4 Hi active
		0 0 1 0	AI3 Disabled, AI4 Hi active
		0 1 0 0	AI3 Hi active, AI4 Lo active
		0 1 0 1	AI3 Lo active, AI4 Lo active
		0 1 1 0	AI3 disabled, AI4 Lo active
		1 0 0 0	AI3 Hi active, AI4 disabled
		1 0 0 1	AI3 Lo active, AI4 disabled
		1 0 1 0	AI3 disabled, AI4 disabled
		0 0	AI3 non-latch, AI4 non-latch
		0 1	AI3 latch, AI4 non-latch
		1 0	AI3 non-latch, AI4 latch
		1 1	AI3 latch, AI4 latch
		0 0	Relay3 On when AI3 active, Relay4 On when AI4 active
		0 1	Relay3 Off when AI3 active, Relay4 On when AI4 active
		1 0	Relay3 On when AI3 active, Relay4 Off when AI4 active
		1 1	Relay3 Off when AI3 active, Relay4 Off when AI4 active
0B (U)	Alarm Config2	Bit 7 6 5 4 3 2 1 0	<u>Alarm Trigger Delay</u>
			<u>60 Hz</u> <u>50Hz</u>
		0 0 0	0.018s 0.021s
		0 0 1	0.035 0.043
		0 1 0	0.07 0.085
		0 1 1	0.14 0.17
		1 0 0	0.28 0.34
		1 0 1	0.56 0.68
		1 1 0	1.13 1.36
		1 1 1	2.27 2.72
		0 0 0	AI1 Band Dev, AI2 Band Dev
		0 0 1	AI1 Hysteresis, AI2 Band Dev
		0 1 0	AI1 Band Dev, AI2 Hysteresis
		0 1 1	AI1 Hysteresis, AI2 Hysteresis
		1 0 0	No deviation in menus or calc
0A (U)	Alarm Config1	Bit 7 6 5 4 3 2 1 0	
		0 0 0 0	AI1 Hi active, AI2 Hi active
		0 0 0 1	AI1 Lo active, AI2 Hi active
		0 0 1 0	AI1 Disabled, AI2 Hi active

		0 1 0 0 AI1 Hi active, AI2 Lo active 0 1 0 1 AI1 Lo active, AI2 Lo active 0 1 1 0 AI1 disabled, AI2 Lo active 1 0 0 0 AI1 Hi active, AI2 disabled 1 0 0 1 AI1 Lo active, AI2 disabled 1 0 1 0 AI1 disabled, AI2 disabled 0 0 AI1 & AI2 non-latching 0 1 AI1 latching, AI2 non-latching 1 0 AI1 non-latching, AI2 latching 1 1 AI1 & AI2 latching 0 0 Relay1 On when AI1 active, Relay2 On when AI2 active 0 1 Relay1 Off when AI1 active, Relay2 On when AI2 active 1 0 Relay1 On when AI1 active, Relay2 Off when AI2 active 1 1 Relay1 Off when AI1 active, Relay2 Off when AI2 active
00 (U)	Serial Cnfg4 (NG to review carefully)	Bit 7 6 5 4 3 2 1 0 <u>Serial Protocol</u> 0 0 No Parity 0 1 Odd Parity 0 0 Custom ASCII protocol (8 bits) 0 1 Modbus RTU protocol (8 bits) 1 0 Modbus ASCII protocol (7 bits) 0 0 1 s Modbus ASCII gap timeout 0 1 3 s Modbus ASCII gap timeout 1 0 5 s Modbus ASCII gap timeout 1 1 10 s Modbus ASCII gap timeout

9.2 DPM 3-BYTE RAM MEMORY DATA

Format for all items except Scale Factor: MS byte Mid byte LS byte

XX XX XX

Format for Scale Factor:

*X XX XX

The 4-bit MS nibble “*” sets the polarity and decimal point according to the following table:

Positive	Negative	Decimal Point
1	9	XXXXX.
2	A	XXXX.X
3	B	XXX.XX
4	C	XX.XXX
5	D	X.XXXX
6	E	.XXXXX

Note: Hex values are 2's complement and absolute values.

9.3 DPM HEX ADDRESSES

MS	Mid	LS	Description
A1 (L)	A0	9F	Analog high value
9E (L)	9D	9C	Analog low value
1B (U)	1A	19	Deviation, Alarm4
18 (U)	17	16	Deviation, Alarm3
9B (L)	9A	99	Deviation, Alarm2
98 (L)	97	96	Deviation, Alarm1
8F (L)	8E	8D	Offset value
8C (L)	8B	8A	Scale factor
15 (U)	14	13	Setpoint4
12 (U)	11	10	Setpoint3
89 (L)	88	87	Setpoint2
86 (L)	85	84	Setpoint1

9.4 DPM NONVOLATILE MEMORY ADDRESSES (2 bytes/address)

Address	MS	LS
75	Setup1	Serial Cnfg3
74	Deviation4 3	Deviation4 2
73	Deviation4 1	Deviation3 3
72	Deviation3 2	Deviation3 1
71	Setpoint4 3	Setpoint4 2
70	Setpoint4 1	Setpoint3 3
6F	Setpoint3 2	Setpoint3 1
6E	Alarm Cnfg4	Alarm Cnfg3
18	Deviation2 3	Deviation2 2
17	Deviation2 1	Deviation1 3
16	Deviation1 2	Deviation1 1
15	Configuration	Sig Cond Type (do not change)
14	Analog Setup	System Decimal Point
13	Lockout2	Lockout 1
12	Serial Cnfg2	Serial Cnfg 1
11	Options	Filter
10	Setup	Input Type
0F	Alarm Cnfg2	Alarm Cnfg 1
0E	Analog High 3	Analog High 2
0D	Analog High 1	Analog Low 3
0C	Analog Low 2	Analog Low 1
0B	High Reading 3	High Reading 2

0A	High Reading 1	High Input 3
09	High Input 2	High Input 1
08	Low Reading 3	Low Reading 2
07	Low Reading 1	Low Input 3
06	Low Input 2	Low Input 1
05	Offset 3	Offset 2
04	Offset 1	Scale Factor 3
03	Scale Factor 2	Scale Factor 1
02	Setpoint2 3	Setpoint2 2
01	Setpoint2 1	Setpoint1 3
00	Setpoint1 2	Setpoint1 1

10. APPENDIX B: COUNTER / TIMER MEMORY ADDRESSES AND DATA DEFINITIONS

10.1 COUNTER / TIMER 1-BYTE RAM MEMORY DATA

(L) = Lower memory, (U) = Upper memory

Hex Address	Item Name	Bit Assignment																																																																																																												
43	Resolution	<table style="width: 100%; border-collapse: collapse;"> <tr> <td style="text-align: right;">Bit 7</td> <td style="text-align: right;">6</td> <td style="text-align: right;">5</td> <td style="text-align: right;">4</td> <td style="text-align: right;">3</td> <td style="text-align: right;">2</td> <td style="text-align: right;">1</td> <td style="text-align: right;">0</td> <td style="text-align: left;"><u>Multiplier</u></td> </tr> <tr> <td></td> <td></td> <td></td> <td></td> <td></td> <td></td> <td></td> <td style="text-align: center;">0</td> <td style="text-align: left;">0.00001</td> </tr> <tr> <td></td> <td></td> <td></td> <td></td> <td></td> <td></td> <td></td> <td style="text-align: center;">1</td> <td style="text-align: left;">0.0001</td> </tr> <tr> <td></td> <td></td> <td></td> <td></td> <td></td> <td></td> <td style="text-align: center;">1</td> <td style="text-align: center;">0</td> <td style="text-align: left;">0.001</td> </tr> <tr> <td></td> <td></td> <td></td> <td></td> <td></td> <td></td> <td style="text-align: center;">1</td> <td style="text-align: center;">1</td> <td style="text-align: left;">0.01</td> </tr> <tr> <td></td> <td></td> <td></td> <td></td> <td style="text-align: center;">1</td> <td style="text-align: center;">0</td> <td style="text-align: center;">0</td> <td></td> <td style="text-align: left;">0.1</td> </tr> <tr> <td></td> <td></td> <td></td> <td></td> <td style="text-align: center;">1</td> <td style="text-align: center;">0</td> <td style="text-align: center;">1</td> <td></td> <td style="text-align: left;">1</td> </tr> <tr> <td></td> <td></td> <td></td> <td></td> <td style="text-align: center;">1</td> <td style="text-align: center;">1</td> <td style="text-align: center;">0</td> <td></td> <td style="text-align: left;">10</td> </tr> <tr> <td></td> <td></td> <td></td> <td></td> <td style="text-align: center;">1</td> <td style="text-align: center;">1</td> <td style="text-align: center;">1</td> <td></td> <td style="text-align: left;">100</td> </tr> <tr> <td></td> <td></td> <td></td> <td style="text-align: center;">1</td> <td style="text-align: center;">0</td> <td style="text-align: center;">0</td> <td style="text-align: center;">0</td> <td></td> <td style="text-align: left;">1000</td> </tr> <tr> <td></td> <td></td> <td></td> <td style="text-align: center;">1</td> <td style="text-align: center;">0</td> <td style="text-align: center;">0</td> <td style="text-align: center;">1</td> <td></td> <td style="text-align: left;">10000</td> </tr> <tr> <td></td> <td></td> <td></td> <td style="text-align: center;">1</td> <td style="text-align: center;">0</td> <td style="text-align: center;">1</td> <td style="text-align: center;">0</td> <td></td> <td style="text-align: left;">100000</td> </tr> </table>	Bit 7	6	5	4	3	2	1	0	<u>Multiplier</u>								0	0.00001								1	0.0001							1	0	0.001							1	1	0.01					1	0	0		0.1					1	0	1		1					1	1	0		10					1	1	1		100				1	0	0	0		1000				1	0	0	1		10000				1	0	1	0		100000
Bit 7	6	5	4	3	2	1	0	<u>Multiplier</u>																																																																																																						
							0	0.00001																																																																																																						
							1	0.0001																																																																																																						
						1	0	0.001																																																																																																						
						1	1	0.01																																																																																																						
				1	0	0		0.1																																																																																																						
				1	0	1		1																																																																																																						
				1	1	0		10																																																																																																						
				1	1	1		100																																																																																																						
			1	0	0	0		1000																																																																																																						
			1	0	0	1		10000																																																																																																						
			1	0	1	0		100000																																																																																																						
42	Recog. Char.	ASCII value of custom recognition character																																																																																																												
41	Slope	<table style="width: 100%; border-collapse: collapse;"> <tr> <td style="text-align: right;">Bit 7</td> <td style="text-align: right;">6</td> <td style="text-align: right;">5</td> <td style="text-align: right;">4</td> <td style="text-align: right;">3</td> <td style="text-align: right;">2</td> <td style="text-align: right;">1</td> <td style="text-align: right;">0</td> <td></td> </tr> <tr> <td></td> <td></td> <td></td> <td></td> <td></td> <td></td> <td></td> <td style="text-align: center;">0</td> <td style="text-align: left;">Positive slope Channel B</td> </tr> <tr> <td></td> <td></td> <td></td> <td></td> <td></td> <td></td> <td></td> <td style="text-align: center;">1</td> <td style="text-align: left;">Negative slope Channel B</td> </tr> <tr> <td></td> <td></td> <td></td> <td></td> <td></td> <td></td> <td style="text-align: center;">0</td> <td></td> <td style="text-align: left;">Positive slope Channel A</td> </tr> <tr> <td></td> <td></td> <td></td> <td></td> <td></td> <td></td> <td style="text-align: center;">1</td> <td></td> <td style="text-align: left;">Negative slope Channel A</td> </tr> </table>	Bit 7	6	5	4	3	2	1	0									0	Positive slope Channel B								1	Negative slope Channel B							0		Positive slope Channel A							1		Negative slope Channel A																																																															
Bit 7	6	5	4	3	2	1	0																																																																																																							
							0	Positive slope Channel B																																																																																																						
							1	Negative slope Channel B																																																																																																						
						0		Positive slope Channel A																																																																																																						
						1		Negative slope Channel A																																																																																																						
3E	Scale Multiplier	<table style="width: 100%; border-collapse: collapse;"> <tr> <td style="width: 50%;">Bits 3-0 = 0-A</td> <td>SCALE1 multiplier</td> </tr> <tr> <td>Bits 7-4 = 0-A</td> <td>SCALE2 multiplier</td> </tr> <tr> <td>0-A:</td> <td>Same multiplier as for Resolution</td> </tr> </table>	Bits 3-0 = 0-A	SCALE1 multiplier	Bits 7-4 = 0-A	SCALE2 multiplier	0-A:	Same multiplier as for Resolution																																																																																																						
Bits 3-0 = 0-A	SCALE1 multiplier																																																																																																													
Bits 7-4 = 0-A	SCALE2 multiplier																																																																																																													
0-A:	Same multiplier as for Resolution																																																																																																													
3D	Analog Setup	<table style="width: 100%; border-collapse: collapse;"> <tr> <td style="text-align: right;">Bit 7</td> <td style="text-align: right;">6</td> <td style="text-align: right;">5</td> <td style="text-align: right;">4</td> <td style="text-align: right;">3</td> <td style="text-align: right;">2</td> <td style="text-align: right;">1</td> <td style="text-align: right;">0</td> <td style="text-align: left;">Analog Output Source</td> </tr> <tr> <td></td> <td></td> <td></td> <td></td> <td></td> <td></td> <td style="text-align: center;">0</td> <td style="text-align: center;">0</td> <td style="text-align: left;">Filtered Item</td> </tr> <tr> <td></td> <td></td> <td></td> <td></td> <td></td> <td></td> <td style="text-align: center;">0</td> <td style="text-align: center;">1</td> <td style="text-align: left;">Item 1</td> </tr> <tr> <td></td> <td></td> <td></td> <td></td> <td></td> <td></td> <td style="text-align: center;">1</td> <td style="text-align: center;">0</td> <td style="text-align: left;">Item 2</td> </tr> <tr> <td></td> <td></td> <td></td> <td></td> <td></td> <td></td> <td style="text-align: center;">1</td> <td style="text-align: center;">1</td> <td style="text-align: left;">Item 3</td> </tr> <tr> <td></td> <td></td> <td></td> <td></td> <td></td> <td style="text-align: center;">0</td> <td></td> <td></td> <td style="text-align: left;">Current output</td> </tr> <tr> <td></td> <td></td> <td></td> <td></td> <td></td> <td style="text-align: center;">1</td> <td></td> <td></td> <td style="text-align: left;">Analog voltage output</td> </tr> </table>	Bit 7	6	5	4	3	2	1	0	Analog Output Source							0	0	Filtered Item							0	1	Item 1							1	0	Item 2							1	1	Item 3						0			Current output						1			Analog voltage output																																													
Bit 7	6	5	4	3	2	1	0	Analog Output Source																																																																																																						
						0	0	Filtered Item																																																																																																						
						0	1	Item 1																																																																																																						
						1	0	Item 2																																																																																																						
						1	1	Item 3																																																																																																						
					0			Current output																																																																																																						
					1			Analog voltage output																																																																																																						
3C	Source	<table style="width: 100%; border-collapse: collapse;"> <tr> <td style="text-align: right;">Bit 7</td> <td style="text-align: right;">6</td> <td style="text-align: right;">5</td> <td style="text-align: right;">4</td> <td style="text-align: right;">3</td> <td style="text-align: right;">2</td> <td style="text-align: right;">1</td> <td style="text-align: right;">0</td> <td></td> </tr> <tr> <td></td> <td></td> <td></td> <td></td> <td></td> <td></td> <td></td> <td style="text-align: center;">0</td> <td style="text-align: center;">0</td> <td style="text-align: left;">Compare Setpoint 2 to:</td> </tr> <tr> <td></td> <td></td> <td></td> <td></td> <td></td> <td></td> <td></td> <td style="text-align: center;">0</td> <td style="text-align: center;">0</td> <td style="text-align: left;">Filtered Item</td> </tr> </table>	Bit 7	6	5	4	3	2	1	0									0	0	Compare Setpoint 2 to:								0	0	Filtered Item																																																																															
Bit 7	6	5	4	3	2	1	0																																																																																																							
							0	0	Compare Setpoint 2 to:																																																																																																					
							0	0	Filtered Item																																																																																																					

		0 1 Item 1 1 0 Item 2 1 1 Item 3 Compare Setpoint 1 to: 0 0 Filtered Item 0 1 Item 1 1 0 Item 2 1 1 Item 3
36	Lockout2 0 = unlocked 1 = locked	Bit 7 6 5 4 3 2 1 0 1 Change Item # 1 CALib 1 Ser 1, Ser 2, Ser 3 1 An Lo, An Hi, An SEt 1 Front Panel meter reset 1 Front Panel Peak, Latched resets 1 View alarm setpoints 1 View Peak locked
35	Lockout1 0 = unlocked 1 = locked	Bit 7 6 5 4 3 2 1 0 1 FiLtEr 1 Gate t, time out, batch, pulses 1 SEtuP, ConFiG 1 InPut 1 Change Setpoints 1 SourcE,AL SEt,dEVn1b,1H,2b,2H 1 SCALE, OFFSEt, Coords, rESoLn 1 SLOPE, dECPt
34	Configuration	Bit 7 6 5 4 3 2 1 0 0 Sample time total zero cutoff 1 Sample time total allow negative 0 Linear input 1 Square Root of input 0 0 Basic Counter 0 1 Ext. Counter 1 0 Ext. Counter, Custom curve #1 1 1 Ext. Counter, Custom curve #2 <u>Display mode:</u> 0 0 0 0 Normal, Exponential Overload 0 0 0 1 Normal, 999999 Flashing Overload 0 0 1 0 1 Right-Hand dummy zero 0 0 1 1 2 Right-Hand dummy zeros

		0 1 0 0 0 1 0 1 0 1 1 0 0 1 1 1 1 0 0 0 1 0 0 1 1 0 1 0 1 0 1 1 1 1 0 0	Clock Time, Stopwatch, Multi-format Clock Time, Stopwatch, hh.mm.ss Remote Display, Addressable Remote Display, Single Value Slave Display, 1st data value of string Slave Display, 2nd data value of string Slave Display, 3rd data value of string Slave Display, 4th data value of string Masked display
33	Serial Cnfg3	Bit 7 6 5 4 3 2 1 0 0 0 0 0 0 1 0 1 0 0 1 1 1 0 0 1 0 1 0 1 0 1 0 1 0 1	Transmit: All active items Item #1 only Item #2 only Item #3 only Peak value only All active items + Peak Term chars end of all items Term chars end of each item Non-Latching RTS Latching RTS "*" recog character Custom recognition character Full Duplex Half Duplex
32	Serial Cnfg2	Bit 7 6 5 4 3 2 1 0 X X X X X 1 1 1	Counter address 0-31 (5 bits) Command Mode (0 = Continuous) Alarm data included with reading (0 = excluded) LF following CR (0=no LF)
31	Serial Cnfg1	Bit 7 6 5 4 3 2 1 0 0 0 0 0 0 0 0 1 0 0 1 0 0 0 1 1 0 1 0 0 0 1 0 1 0 1 1 0 0 1 1 1 1 0 0 0	<u>Continuous output data rate:</u> Reading rate Reading rate / 2 Reading rate / 4 Reading rate / 8 Reading rate / 16 Reading rate / 32 Reading rate / 64 Reading rate / 128 Reading rate / 256 <u>Baud rate:</u>

		1 1 0 1 Peak Display Display Blank 1 1 1 0 Display Blank External Gate 1 1 1 1 Display item#2 Display item#3 0 Scale2, Offset2 entered directly 1 Scale2, Offset2 using Coordinates of 2 points 0 Scale1, Offset1 entered directly 1 Scale1, Offset1 using Coordinates of 2 points 0 Blank leading zeros 1 Display leading zeros (0 = Blank leading zeros) 0 Zero the total at power on 1 Restore total at power-on																																								
2B	Input Type	Dual Channel Signal Conditioner																																								
		<table border="1"> <thead> <tr> <th>Rate</th> <th>Period</th> <th>Total</th> <th>Time Interval</th> </tr> </thead> <tbody> <tr> <td>00 A,B</td> <td>10 A,B</td> <td>20 A,B</td> <td>41 A to B</td> </tr> <tr> <td>01 A only</td> <td>11 A only</td> <td>21 A only</td> <td rowspan="2">Stopwatch</td> </tr> <tr> <td>02 Batch</td> <td>1B A+B</td> <td>24 A-B updown</td> </tr> <tr> <td>03 A, Atot</td> <td>1C A-B</td> <td>26 Burst</td> <td>50 A to A</td> </tr> <tr> <td>05 A, Btot</td> <td>1D AxB</td> <td>27 B, Arate</td> <td>51 A to B</td> </tr> <tr> <td>0B A+B</td> <td></td> <td>29 A,Bup/down</td> <td rowspan="2">Phase</td> </tr> <tr> <td>0C A-B</td> <td></td> <td>2A A, Binhibit</td> </tr> <tr> <td>0D AxB</td> <td></td> <td>2B A+B</td> <td rowspan="3">61 A to B</td> </tr> <tr> <td>0E A/B</td> <td></td> <td>2C A-B</td> </tr> <tr> <td>0F A/B-1</td> <td></td> <td>2D AxB 2E A/B</td> </tr> </tbody> </table>	Rate	Period	Total	Time Interval	00 A,B	10 A,B	20 A,B	41 A to B	01 A only	11 A only	21 A only	Stopwatch	02 Batch	1B A+B	24 A-B updown	03 A, Atot	1C A-B	26 Burst	50 A to A	05 A, Btot	1D AxB	27 B, Arate	51 A to B	0B A+B		29 A,Bup/down	Phase	0C A-B		2A A, Binhibit	0D AxB		2B A+B	61 A to B	0E A/B		2C A-B	0F A/B-1		2D AxB 2E A/B
		Rate	Period	Total	Time Interval																																					
		00 A,B	10 A,B	20 A,B	41 A to B																																					
		01 A only	11 A only	21 A only	Stopwatch																																					
		02 Batch	1B A+B	24 A-B updown																																						
		03 A, Atot	1C A-B	26 Burst	50 A to A																																					
		05 A, Btot	1D AxB	27 B, Arate	51 A to B																																					
		0B A+B		29 A,Bup/down	Phase																																					
		0C A-B		2A A, Binhibit																																						
0D AxB		2B A+B	61 A to B																																							
0E A/B		2C A-B																																								
0F A/B-1		2D AxB 2E A/B																																								
VF Converter																																										
4-20 mA	0-1 mA	0-10V																																								
81 A only	91 A only	A1 A only																																								
82 Batch	92 Batch	A2 Batch																																								
83 A, Atotal	93 A, Atotal	A3 A, Atotal																																								
88 Atot, A	98 Atot, A	A8 Atot, A																																								
8F 1/A	9F 1/A	AF 1/A																																								
Quadrature																																										
C0 Total																																										
2C	Alarm Cnfg2	Bit 7 6 5 4 3 2 1 0 #Consecutive readings to Alarm																																								
		0 0 0 1																																								
		0 0 1 2																																								
		0 1 0 4																																								

									0 1 1	8	
									1 0 0	16	
									1 0 1	32	
									1 1 0	64	
									1 1 1	128	
									0		Alarm1 Band Deviation
									1		Alarm1 Hysteresis
									0		Alarm2 Band Deviation
									1		Alarm2 Hysteresis
2B	Alarm Cnfg1	Bit 7	6	5	4	3	2	1	0		
										0 0 0 0	AI1 Hi Active, AI2 Hi Active
										0 0 0 1	AI1 Lo Active, AI2 Hi Active
										0 0 1 0	AI1 Disabled, AI2 Hi Active
										0 1 0 0	AI1 Hi Active, AI2 Lo Active
										0 1 0 1	AI1 Lo Active, AI2 Lo Active
										0 1 1 0	AI1 Disabled, AI2 Lo Active
										1 0 0 0	AI1 Hi Active, AI2 Disabled
										1 0 0 1	AI1 Lo Active, AI2 Disabled
										1 0 1 0	AI1 Disabled, AI2 Disabled
				0	0						AI1 Non-Latch, AI2 Non-Latch
				0	1						AI1 Latch, AI2 Non-Latch
				1	0						AI1 Non-Latch, AI2 Latch
				1	1						AI1 Latch, AI2 Latch
		0	0								Relay1 On when AI1 active, Relay2 On when AI2 active
		0	1								Relay1 Off when AI1 active, Relay2 On when AI2 active
		1	0								Relay1 On when AI1 active, Relay2 Off when AI2 active
		1	1								Relay1 Off when AI1 active, Relay2 Off when AI2 active

10.2 COUNTER / TIMER 2-BYTE RAM DATA TABLE

Hex MS	Hex LS	Name	Hex Range	Dec Range
40	3F	Pulses	0000 – EA5F	0 – 59999 Positive magnitude (Units = 1)
3A	39	Timeout	0000 – 4E1F	0 – 19999 Positive magnitude (Units = 0.01 sec)
38	37	Gatetime	0000 – 4E1F	0 – 19999 Positive magnitude (Units = 0.01 sec)

10.3 COUNTER / TIMER 3-BYTE RAM DATA TABLE

Values stored as 3-byte 2's complement

Hex MS	Hex Mid	Hex LS	Name
B0	AF	AE	Deviation2 (values always+) (Hysteresis2)
AA	A9	A8	Offset2
9E	9D	9C	Setpoint2
AD	AC	AB	Deviation1 (values always+) (Hysteresis1)
A4	A3	A2	Offset 1
9B	9A	99	Setpoint1

Values stored as sign (MS bit) + magnitude (all other bits), fixed DP = 6

Hex MS	Hex Mid	Hex LS	Name
A7	A6	A5	Scale2
A1	A0	9F	Scale1

10.4 COUNTER / TIMER NON-VOLATILE MEMORY ADDRESSES (2 bytes / address)

Sign + Magnitude	XXXX XXXX XXXX XXXX XXXX XXXX XXXX S Magnitude	S = Sign Sign = 1 for negative DP = 1 for DDDDDD. DP = 6 for D.DDDDD
Sign + DP + Magnitude	XXXX XXXX XXXX XXXX XXXX XXXX XXXX S DP Magnitude	

Hex Address	MS Byte	LS Byte	Stored As
74	Deviation4 Byte 3	Deviaion4 Byte 2	Magnitude
73	Deviation4 Byte 1	Deviation3 Byte 3	Magnitude
72	Deviation3 Byte 2	Deviation3 Byte 1	Magnitude
71	Setpoint4 Byte 3	Setpoint4 Byte 2	2's Complement
70	Setpoint4 Byte 1	Setpoint3 Byte 3	2's Complement
6F	Setpoint3 Byte 2	Setpoint3 Byte 1	2's Complement
6E	Alarm Confg4	Alarm Confg3	Bits
6D	Version	M Type	Magnitude
6C	T Stop	T Start	Bytes
6B	R Show	R Skip	Magnitude
6A	R Stop	R Start	Bytes
32	Serial Confg4	Modbus Address	Magnitude
31	Total A Byte 6	Total A Byte 5	Magnitude
30	Total A Byte 4	Total A Byte 3	Magnitude
2F	Total A Byte 2	Total A Byte 1	Magnitude
2E	Total B Byte 6	Total B Byte 5	Magnitude

2D	Total B Byte 4	Total B Byte 3	Magnitude
2C	Total B Byte 2	Total B Byte 1	Magnitude
2A	Spare	Analog Type	Bits
29	Cutoff Byte 2	Cutoff Byte 1	Magnitude
28	Recog Character	System Decimal Point	Bits
27	Do not use	Resolution	Bits
26	Display Item	Slope	Bits
25	Pulses Byte 2	Pulses Byte 1	Magnitude
24	Scale Multiplier	Analog Output Setup	Bits
23	Source	Batch	Bits
22	Timeout Byte 2	Timeout Byte 1	Magnitude
21	Gate Time Byte 2	Gate Time Byte 1	Magnitude
20	Lockout Byte 2	Lockout Byte 1	Bits
1F	Config	Serial Config Byte 3	Bits
1E	Serial Config Byte 2	Serial Config Byte 1	Bits
1D	Options	Filter	Bits
1C	Setup	Input Type	Bits
1B	Alarm Config Byte 2	Alarm Config Byte 2	Bits
1A	Analog High Byte 3	Analog High Byte 2	2's Complement
19	Analog High Byte 1	Analog Low Byte 3	2's Complement
18	Analog Low Byte 2	Analog Low Byte 1	2's Complement
17	Deviation2 Byte 3	Deviation2 Byte 2	2's Complement
16	Deviation2 Byte 1	Deviation1 Byte 3	2's Complement
15	Deviation1 Byte 2	Deviation1 Byte 1	2's Complement
14	Offset2 Byte 3	Offset2 Byte 2	2's Complement
13	Offset2 Byte 1	Scale2 Byte 3	2's Complement
12	Scale2 Byte 2	Scale2 Byte 1	2's Complement
11	Offset1 Byte 3	Offset1 Byte 2	2's Complement
10	Offset1 Byte 1	Scale1 Byte 3	2's Complement
0F	Scale1 Byte 2	Scale1 Byte 1	2's Complement
0E	Setpoint2 Byte 3	Setpoint2 Byte 2	2's Complement
0D	Setpoint2 Byte 1	Setpoint1 Byte 3	2's Complement
0C	Setpoint1 Byte 2	Setpoint1 Byte 1	2's Complement
0B	High Reading2 Byte 3	High Reading2 2	2's Complement
0A	High Reading2 Byte 1	High Input2 Byte 3	2's Complement
09	High Input2 Byte 2	High Input2 Byte 1	2's Complement
08	Low Reading2 Byte 3	Low Reading2 Byte 2	2's Complement
07	Low Reading2 Byte 1	Low Input2 Byte 3	2's Complement
06	Low Input2 Byte 2	Low Input2 Byte 1	2's Complement
05	High Reading1 Byte 3	High Reading1 Byte 2	2's Complement
04	High Reading1 Byte 1	High Input1 3	2's Complement
03	High Input1 Byte 2	High Input1 1	2's Complement

02	Low Reading1 Byte 3	Low Reading1 Byte 2	2's Complement
01	Low Reading1 Byte 1	Low Input1 3	2's Complement
00	Low Input1 2	Low Input1 1	2's Complement

11. APPENDIX C: WEIGHT METER MEMORY ADDRESSES AND DATA DEFINITIONS

11.1 WEIGHT METER 1-BYTE RAM MEMORY DATA

(L) = Lower memory, (U) = Upper memory

Hex Address	Item Name	Bit Assignment																																																																																																																																																									
BF (L)	Analog Setup	<table style="width: 100%; border-collapse: collapse;"> <tr> <td style="width: 10%;">Bit 7</td> <td style="width: 10%;">6</td> <td style="width: 10%;">5</td> <td style="width: 10%;">4</td> <td style="width: 10%;">3</td> <td style="width: 10%;">2</td> <td style="width: 10%;">1</td> <td style="width: 10%;">0</td> <td></td> </tr> <tr> <td></td> <td></td> <td></td> <td></td> <td></td> <td></td> <td></td> <td>0</td> <td>Analog output unfiltered</td> </tr> <tr> <td></td> <td></td> <td></td> <td></td> <td></td> <td></td> <td></td> <td>1</td> <td>Analog output filtered</td> </tr> <tr> <td></td> <td></td> <td></td> <td></td> <td></td> <td>0</td> <td>0</td> <td></td> <td>0-20 mA current output</td> </tr> <tr> <td></td> <td></td> <td></td> <td></td> <td></td> <td>0</td> <td>1</td> <td></td> <td>0-10V voltage output</td> </tr> <tr> <td></td> <td></td> <td></td> <td></td> <td></td> <td>1</td> <td>0</td> <td></td> <td>4-20 mA current output</td> </tr> </table>	Bit 7	6	5	4	3	2	1	0									0	Analog output unfiltered								1	Analog output filtered						0	0		0-20 mA current output						0	1		0-10V voltage output						1	0		4-20 mA current output																																																																																																			
Bit 7	6	5	4	3	2	1	0																																																																																																																																																				
							0	Analog output unfiltered																																																																																																																																																			
							1	Analog output filtered																																																																																																																																																			
					0	0		0-20 mA current output																																																																																																																																																			
					0	1		0-10V voltage output																																																																																																																																																			
					1	0		4-20 mA current output																																																																																																																																																			
6B (L)	Configuration	<table style="width: 100%; border-collapse: collapse;"> <tr> <td style="width: 10%;">Bit 7</td> <td style="width: 10%;">6</td> <td style="width: 10%;">5</td> <td style="width: 10%;">4</td> <td style="width: 10%;">3</td> <td style="width: 10%;">2</td> <td style="width: 10%;">1</td> <td style="width: 10%;">0</td> <td></td> </tr> <tr> <td></td> <td></td> <td></td> <td></td> <td></td> <td></td> <td></td> <td>0</td> <td>Linear data</td> </tr> <tr> <td></td> <td></td> <td></td> <td></td> <td></td> <td></td> <td></td> <td>1</td> <td>Custom curve (Extended DPM)</td> </tr> <tr> <td></td> <td></td> <td></td> <td></td> <td></td> <td></td> <td>0</td> <td></td> <td>Peak of Net value</td> </tr> <tr> <td></td> <td></td> <td></td> <td></td> <td></td> <td></td> <td>1</td> <td></td> <td>Peak of Gross value</td> </tr> <tr> <td></td> <td></td> <td></td> <td></td> <td></td> <td>0</td> <td></td> <td></td> <td>Dribble enabled</td> </tr> <tr> <td></td> <td></td> <td></td> <td></td> <td></td> <td>1</td> <td></td> <td></td> <td>Dribble disabled</td> </tr> <tr> <td></td> <td></td> <td></td> <td>0</td> <td>0</td> <td></td> <td></td> <td></td> <td>Peak button displays Peak</td> </tr> <tr> <td></td> <td></td> <td></td> <td>0</td> <td>1</td> <td></td> <td></td> <td></td> <td>Peak button displays Valley</td> </tr> <tr> <td></td> <td></td> <td></td> <td>1</td> <td>0</td> <td></td> <td></td> <td></td> <td>Peak b. displays Peak then Valley</td> </tr> <tr> <td></td> <td></td> <td>0</td> <td>0</td> <td>0</td> <td></td> <td></td> <td></td> <td>Not rate</td> </tr> <tr> <td></td> <td></td> <td>0</td> <td>0</td> <td>1</td> <td></td> <td></td> <td></td> <td>Rate x 0.1</td> </tr> <tr> <td></td> <td></td> <td>0</td> <td>1</td> <td>0</td> <td></td> <td></td> <td></td> <td>Rate x 1</td> </tr> <tr> <td></td> <td></td> <td>0</td> <td>1</td> <td>1</td> <td></td> <td></td> <td></td> <td>Rate x 10</td> </tr> <tr> <td></td> <td></td> <td>1</td> <td>0</td> <td>0</td> <td></td> <td></td> <td></td> <td>Rate x 100</td> </tr> <tr> <td></td> <td></td> <td>1</td> <td>0</td> <td>1</td> <td></td> <td></td> <td></td> <td>Rate x 1000</td> </tr> <tr> <td></td> <td></td> <td>1</td> <td>1</td> <td>0</td> <td></td> <td></td> <td></td> <td>Rate x 10,000</td> </tr> </table>	Bit 7	6	5	4	3	2	1	0									0	Linear data								1	Custom curve (Extended DPM)							0		Peak of Net value							1		Peak of Gross value						0			Dribble enabled						1			Dribble disabled				0	0				Peak button displays Peak				0	1				Peak button displays Valley				1	0				Peak b. displays Peak then Valley			0	0	0				Not rate			0	0	1				Rate x 0.1			0	1	0				Rate x 1			0	1	1				Rate x 10			1	0	0				Rate x 100			1	0	1				Rate x 1000			1	1	0				Rate x 10,000
Bit 7	6	5	4	3	2	1	0																																																																																																																																																				
							0	Linear data																																																																																																																																																			
							1	Custom curve (Extended DPM)																																																																																																																																																			
						0		Peak of Net value																																																																																																																																																			
						1		Peak of Gross value																																																																																																																																																			
					0			Dribble enabled																																																																																																																																																			
					1			Dribble disabled																																																																																																																																																			
			0	0				Peak button displays Peak																																																																																																																																																			
			0	1				Peak button displays Valley																																																																																																																																																			
			1	0				Peak b. displays Peak then Valley																																																																																																																																																			
		0	0	0				Not rate																																																																																																																																																			
		0	0	1				Rate x 0.1																																																																																																																																																			
		0	1	0				Rate x 1																																																																																																																																																			
		0	1	1				Rate x 10																																																																																																																																																			
		1	0	0				Rate x 100																																																																																																																																																			
		1	0	1				Rate x 1000																																																																																																																																																			
		1	1	0				Rate x 10,000																																																																																																																																																			
35 (L)	System Decimal Point	<table style="width: 100%; border-collapse: collapse;"> <tr> <td style="width: 10%;">Bit 7</td> <td style="width: 10%;">6</td> <td style="width: 10%;">5</td> <td style="width: 10%;">4</td> <td style="width: 10%;">3</td> <td style="width: 10%;">2</td> <td style="width: 10%;">1</td> <td style="width: 10%;">0</td> <td><u>Meter Display</u></td> </tr> <tr> <td></td> <td></td> <td></td> <td></td> <td></td> <td>0</td> <td>0</td> <td>1</td> <td>XXXXX. (dec point not displayed)</td> </tr> <tr> <td></td> <td></td> <td></td> <td></td> <td></td> <td>0</td> <td>1</td> <td>0</td> <td>XXXX.X</td> </tr> <tr> <td></td> <td></td> <td></td> <td></td> <td></td> <td>0</td> <td>1</td> <td>1</td> <td>XXX.XX</td> </tr> <tr> <td></td> <td></td> <td></td> <td></td> <td></td> <td>1</td> <td>0</td> <td>0</td> <td>XX.XXX</td> </tr> <tr> <td></td> <td></td> <td></td> <td></td> <td></td> <td>1</td> <td>0</td> <td>1</td> <td>X.XXXX</td> </tr> <tr> <td></td> <td></td> <td></td> <td></td> <td></td> <td>1</td> <td>1</td> <td>0</td> <td>.XXXXX</td> </tr> </table>	Bit 7	6	5	4	3	2	1	0	<u>Meter Display</u>						0	0	1	XXXXX. (dec point not displayed)						0	1	0	XXXX.X						0	1	1	XXX.XX						1	0	0	XX.XXX						1	0	1	X.XXXX						1	1	0	.XXXXX																																																																																										
Bit 7	6	5	4	3	2	1	0	<u>Meter Display</u>																																																																																																																																																			
					0	0	1	XXXXX. (dec point not displayed)																																																																																																																																																			
					0	1	0	XXXX.X																																																																																																																																																			
					0	1	1	XXX.XX																																																																																																																																																			
					1	0	0	XX.XXX																																																																																																																																																			
					1	0	1	X.XXXX																																																																																																																																																			
					1	1	0	.XXXXX																																																																																																																																																			
34 (L)	Lockout2 0 = unlocked	<table style="width: 100%; border-collapse: collapse;"> <tr> <td style="width: 10%;">Bit 7</td> <td style="width: 10%;">6</td> <td style="width: 10%;">5</td> <td style="width: 10%;">4</td> <td style="width: 10%;">3</td> <td style="width: 10%;">2</td> <td style="width: 10%;">1</td> <td style="width: 10%;">0</td> <td><u>Front Panel Setup Menu Item</u></td> </tr> <tr> <td></td> <td></td> <td></td> <td></td> <td></td> <td></td> <td></td> <td>1</td> <td>Serial comm configuration</td> </tr> </table>	Bit 7	6	5	4	3	2	1	0	<u>Front Panel Setup Menu Item</u>								1	Serial comm configuration																																																																																																																																							
Bit 7	6	5	4	3	2	1	0	<u>Front Panel Setup Menu Item</u>																																																																																																																																																			
							1	Serial comm configuration																																																																																																																																																			

		<p>1 1 1 0 38:41 46:25</p> <p>1 1 1 1 1:17:21 1:32:51</p> <p>0 0 0 300 baud</p> <p>0 0 1 600 baud</p> <p>0 1 0 1200 baud</p> <p>0 1 1 2400 baud</p> <p>1 0 0 4800 baud</p> <p>1 0 1 9600 baud</p> <p>1 1 0 19200 baud</p> <p>0 Send unfiltered value</p> <p>1 Send filtered value</p>
2F (L)	Filter	<p>Bit 7 6 5 4 3 2 1 0</p> <p>0 0 0 0 Auto Filter</p> <p>0 0 0 1 Batch (16 samples) filter</p> <p> Time constant <u>60 Hz</u> <u>50 Hz</u></p> <p>0 0 1 0 Moving average 0.07s 0.085s</p> <p>0 0 1 1 Moving average 0.14 0.17</p> <p>0 1 0 0 Moving average 0.28 0.34</p> <p>0 1 0 1 Moving average 0.57 0.68</p> <p>0 1 1 0 Moving average 1.13 1.36</p> <p>0 1 1 1 Moving average 2.27 2.72</p> <p>1 0 0 0 Moving average 4.53 5.44</p> <p>1 0 0 1 Moving average 9.06 10.88</p> <p>1 0 1 0 No filter (used with Hold)</p> <p> 0 Low adaptive threshold</p> <p> 1 High adaptive threshold</p> <p> 0 Display value of 16-reading batch</p> <p> 1 Display value of filtered signal</p> <p>0 Take peak of unfiltered signal</p> <p>1 Take peak of filtered signal</p> <p>0 Alarm from unfiltered signal</p> <p>1 Alarm from filtered signal</p>
17 (L)	Serial Cnfg3	<p>Bit 7 6 5 4 3 2 1 0</p> <p>0 0 0 Net + Gross</p> <p>0 0 1 Net only</p> <p>0 1 0 Gross only</p> <p>0 1 1 Peak only (Net or Gross)</p> <p>1 0 0 Net + Gross + Peak</p> <p>1 0 1 Valley only</p> <p>1 1 0 Net + Gross + Peak + Valley</p> <p>0 <CR> or <CR><LF> at end of all Items</p>

		1	<CR> or <CR><LF> at end of each Item (if no Alarm character)								
		0	Non-latching RTS								
		1	Latching RTS								
		0	Normal continuous TX								
		1	Special Start & Stop characters								
		0	Full duplex								
		1	Half duplex								
6D (L)	Count_	Bit 7	6	5	4	3	2	1	0	<u>Auto-Zero Range</u>	
						0	0	0	0	0 (no auto-zero)	
						0	0	0	1	±1	
						0	0	1	0	±2	
						0	0	1	1	±3	
						0	1	0	0	±4	
						0	1	0	1	±5	
						0	1	1	0	±6	
						0	1	1	1	±7	
						1	0	0	0	±8	
						1	0	0	1	±9	
										<u>Count By</u>	
			0	0	0					1	
			0	0	1					2	
			0	1	0					5	
			0	1	1					10	
			1	0	0					20	
			1	0	1					50	
			1	1	0					100	
35 (U)	Modbus Addr.	00 to FF							Modbus address 0-255 (in Hex format)		
2E (U)	Setup	Bit 7	6	5	4	3	2	1	0	<u>EXT IN A</u>	<u>EXT IN B</u>
	Both Ext In A & Ext In B = Funct Reset					0	0	0	0	Meter Reset	Meter Hold
						0	0	0	1	Funct Reset	Peak or Valley
						0	0	1	0	Meter Hold	Peak or Valley
						0	0	1	1	Meter Hold	Tare
						0	1	0	0	Peak or Valley	Tare
						0	1	0	1	Meter Reset	Tare
						0	1	1	0	Funct Reset	Tare
						0	1	1	1	Tare Reset	Tare
						1	0	0	0	Display Blank	Tare
						1	0	0	1	Meter Reset	Display Blank
	Funct Reset = Alarms, Peak, Valley										

		1 0 1 0 Funct Reset Display Blank 1 0 1 1 Display Item Tare 1 1 0 0 Peak Valley 1 1 0 1 Meter Reset Display Item 1 1 1 0 Funct Reset Display Item 1 1 1 1 Meter Hold Display Item 0 0 Scale using Scale, Offset 0 1 Scale Coord of 2 Points Method 1 0 Scale using reading Coordinates 0 Peak key action = Peak 1 Peak key action = Tare 0 60 Hz power 1 50 Hz power
09 (U)	Setup1	Bit 7 6 5 4 3 2 1 0 0 0 Reset to Net, no dummy zero 0 1 Reset to Net, with dummy zero 1 0 Reset to Gross, no dummy zero 1 1 Reset to Gross, no dummy zero
0D (U)	Alarm Config4	Bit 7 6 5 4 3 2 1 0 <u>Alarm Trigger Delay</u> <u>60 Hz</u> <u>50Hz</u> 0 0 0 0.018 s 0.021 s 0 0 1 0.035 0.043 0 1 0 0.07 0.085 0 1 1 0.14 0.17 1 0 0 0.28 0.34 1 0 1 0.56 0.68 1 1 0 1.13 1.36 1 1 1 2.27 2.72 0 0 0 AI3 Band Dev, AI4 Band Dev 0 0 1 AI3 Hysteresis, AI4 Band Dev 0 1 0 AI3 Band Dev, AI4 Hysteresis 0 1 1 AI3 Hysteresis, AI4 Hysteresis 1 0 0 No deviation in menus or calc
0C (U)	Alarm Config3	Bit 7 6 5 4 3 2 1 0 0 0 0 0 AI3 Hi active, AI4 Hi active 0 0 0 1 AI3 Lo active, AI4 Hi active 0 0 1 0 AI3 Disabled, AI4 Hi active 0 1 0 0 AI3 Hi active, AI4 Lo active 0 1 0 1 AI3 Lo active, AI4 Lo active 0 1 1 0 AI3 disabled, AI4 Lo active

		0 1 Relay1 Off when AI1 active, Relay2 On when AI2 active 1 0 Relay1 On when AI1 active, Relay2 Off when AI2 active 1 1 Relay1 Off when AI1 active, Relay2 Off when AI2 active																																																																																										
00 (U)	Serial Cnfg4 (NG to review carefully)	<table border="0"> <tr> <td>Bit 7</td><td>6</td><td>5</td><td>4</td><td>3</td><td>2</td><td>1</td><td>0</td><td><u>Serial Protocol</u></td> </tr> <tr> <td></td><td></td><td></td><td></td><td></td><td></td><td>1</td><td>0</td><td>No Parity</td> </tr> <tr> <td></td><td></td><td></td><td></td><td></td><td></td><td>1</td><td>1</td><td>Odd Parity</td> </tr> <tr> <td></td><td></td><td></td><td></td><td>0</td><td>0</td><td></td><td></td><td>Custom ASCII protocol (8 bits)</td> </tr> <tr> <td></td><td></td><td></td><td></td><td>0</td><td>1</td><td></td><td></td><td>Modbus RTU protocol (8 bits)</td> </tr> <tr> <td></td><td></td><td></td><td></td><td>1</td><td>0</td><td></td><td></td><td>Modbus ASCII protocol (7 bits)</td> </tr> <tr> <td></td><td></td><td>0</td><td>0</td><td></td><td></td><td></td><td></td><td>1 s Modbus ASCII gap timeout</td> </tr> <tr> <td></td><td></td><td>0</td><td>1</td><td></td><td></td><td></td><td></td><td>3 s Modbus ASCII gap timeout</td> </tr> <tr> <td></td><td></td><td>1</td><td>0</td><td></td><td></td><td></td><td></td><td>5 s Modbus ASCII gap timeout</td> </tr> <tr> <td></td><td></td><td>1</td><td>1</td><td></td><td></td><td></td><td></td><td>10 s Modbus ASCII gap timeout</td> </tr> </table>	Bit 7	6	5	4	3	2	1	0	<u>Serial Protocol</u>							1	0	No Parity							1	1	Odd Parity					0	0			Custom ASCII protocol (8 bits)					0	1			Modbus RTU protocol (8 bits)					1	0			Modbus ASCII protocol (7 bits)			0	0					1 s Modbus ASCII gap timeout			0	1					3 s Modbus ASCII gap timeout			1	0					5 s Modbus ASCII gap timeout			1	1					10 s Modbus ASCII gap timeout
Bit 7	6	5	4	3	2	1	0	<u>Serial Protocol</u>																																																																																				
						1	0	No Parity																																																																																				
						1	1	Odd Parity																																																																																				
				0	0			Custom ASCII protocol (8 bits)																																																																																				
				0	1			Modbus RTU protocol (8 bits)																																																																																				
				1	0			Modbus ASCII protocol (7 bits)																																																																																				
		0	0					1 s Modbus ASCII gap timeout																																																																																				
		0	1					3 s Modbus ASCII gap timeout																																																																																				
		1	0					5 s Modbus ASCII gap timeout																																																																																				
		1	1					10 s Modbus ASCII gap timeout																																																																																				

11.2 WEIGHT METER 3-BYTE RAM MEMORY DATA (3 Bytes / Item)

MS	Mid	LS	Description
A1	A0	9F	Analog high value
9E	9D	9C	Analog low value
1B	1A	19	Deviation Alarm4
18	17	16	Deviation Alarm3
9B	9A	99	Deviation Alarm2
98	97	96	Deviation Alarm1
8F	8E	8D	Offset value
8C	8B	8A	Scale factor
15	14	13	Setpoint4
12	11	10	Setpoint3
89	88	87	Setpoint2
86	85	84	Setpoint1
E4	E3	E2	Tare value
1E	1D	1C	Valley

11.3 WEIGHT METER NONVOLATILE MEMORY HEX ADDRESSES (2 Bytes / Item)

Please see the 1 Byte RAM Data Table for bit definitions.

Hex Address	MS	LS
75	Setup Byte 1	Spare
74	Setpoint4 Diff3 Byte 3	Setpoint4 Diff3 Byte 2
73	Setpoint4 Diff3 Byte 1	Setpoint3 Diff3 Byte 3

72	Setpoint3 Diff3 Byte 2	Setpoint3 Diff3 Byte 1
71	Setpoint4 Byte 3	Setpoint4 Byte 2
70	Setpoint4 Byte 1	Setpoint3 Byte 3
6F	Setpoint3 Byte 2	Setpoint3 Byte 1
6E	Alarm Config Byte 4	Alarm Config Byte 3
6D	Version	M Type
6C	T Stop	T Start
6B	Reserved	Reserved
6A	Reserved	Reserved
1D	Tare Byte 3	Tare Byte 2
1C	Tare Byte 1	Spare
1B	Serial Config Byte 3	Count Byte 1
18	Setpoint 2 Diff Byte 3	Setpoint 2 Diff Byte 2
17	Setpoint 2 Diff Byte 1	Setpoint 1 Diff Byte 3
16	Setpoint 1 Diff Byte 2	Setpoint 1 Diff Byte 1
15	Configuration	SC Type (do not change)
14	Analog Setup	System Decimal Point
13	Lockout Byte 2	Lockout Byte 1
12	Serial Config Byte 2	Serial Config Byte 1
11	Options	Filter
10	Setup	Input Type
0F	Alarm Config Byte 2	Alarm Config Byte 1
0E	Analog High Byte 3	Analog High Byte 2
0D	Analog High Byte 1	Analog Low Byte 3
0C	Analog Low Byte 2	Analog Low Byte 1
0B	High Reading Byte 3	High Reading Byte 2
0A	High Reading Byte 1	High Input Byte 3
09	High Input Byte 2	High Input Byte 1
08	Low Reading Byte 3	Low Reading Byte 2
07	Low Reading Byte 1	Low Input Byte 3
06	Low Input Byte 2	Low Input Byte 1
05	Offset Byte 3	Scale Factor Byte 3
04	Offset Byte 1	Scale Factor Byte 2
03	Scale Factor 2	Scale Factor Byte 1
02	Setpoint2 Byte 3	Setpoint2 Byte 2
01	Setpoint2 Byte 1	Setpoint1 Byte 3
00	Setpoint1 Byte 2	Setpoint1 Byte 1

11.4 WEIGHT METER POLARITY & DECIMAL POINT SELECTION

	MS Byte	Mid Byte	LS Byte
For all items except Scale Factor:	XX	XX	XX
For Scale Factor:	OX	XX	XX

The 4-bit MS nibble “0” sets the polarity and decimal point according to the following table:

4-bit MS nibble “0”	Decimal Point
1	XXXXX.
2	XXXX.X
3	XXX.XX
4	XX.XXX
5	X.XXXX
6	.XXXXX
9	-XXXXX.
A	-XXXX.X
B	-XXX.XX
C	-XX.XXX
D	-X.XXXX
E	-.XXXXX

12. RECOMMENDED SUPPLIERS

12.1 B & B Electronics Manufacturing Co.

707 Dayton Road, Ottawa, IL 61350

Phone: (815) 433-5100, Fax: (815) 433-5109, Website: www.bb-elec.com

B & B offers a variety RS485-to-RS232 converters, RS232-to-RS485 converters, RS485-to-USB converters, and RJ11-to-9 pin adapters. The B & B Model 485OT9L is the recommended RS485-to-RS232 converter for use with the products covered in this manual.

13. WARRANTY

Electro-Numerics, Inc. warrants these products to be free of defects in materials and workmanship for two years from the date of shipment to the original customer. This warranty may be considered as unconditional provided that, in the opinion of Electro-Numerics, the equipment has not been mechanically, environmentally, or electrically abused and has been installed, maintained and operated within the limits of rated or normal usage. Defective products must be sent, transportation charges prepaid, with notice of the defect, to our plant in Temecula CA.

This warranty is limited, at the option of Electro-Numerics, Inc. to repair, replacement, or an appropriate credit adjustment not to exceed the original equipment sales price. All warranty freight charges are F.O.B. our plant, Temecula, CA.

Electro-Numerics assumes no responsibility in connection with the sale of its products beyond that stated above and is not responsible for any incidental or consequential loss or damage which might result from a failure of any Electro-Numerics, Inc. product.



ELECTRO-NUMERICS, INC.

42213 Sarah Way, Temecula CA 92590

Tel: **800-854-8530** (U.S.A.)

Tel: 951-699-2437, Fax: 951-695-7246

Web Site: www.ElectroNumerics.com